

Sveučilišni poslijediplomski doktorski studij matematike

Sveučilište u Zagrebu

Zoran Tomljanović

Optimal damping for vibrating systems using dimension reduction

Supervisors: Prof. Ninoslav Truhar
Department of Mathematics, University of Osijek

Prof. Peter Benner
Max Planck Institut für Dynamik komplexer
technischer Systeme, Magdeburg

Prof. Zlatko Drmač
Department of Mathematics, University of Zagreb

Zagreb, 2011.

To my wife Anita,
daughter Kalista and son Teo

Contents

Acknowledgements	v
1 Introduction	1
1.1 Motivation	1
1.2 Problem formulation	3
1.3 Organization of the thesis	12
2 Optimal damping of all eigenfrequencies using dimension reduction	17
2.1 Solving Lyapunov equations using dimension reduction: basic idea	19
2.1.1 Connection of small elements in damping with the structure of the matrix Φ	22
2.2 Solving Lyapunov equations using dimension reduction: general case	25
2.3 Error bound	28
2.4 Calculation of the optimal viscosities	33
2.5 Numerical experiments	35
2.6 Conclusions	40
3 Optimal damping of selected eigenfrequencies using dimension reduction	43
3.1 Approximating the trace of the solution of the Lyapunov equation	45
3.2 Error bound	50
3.3 An algorithm for the approximation of optimal viscosities	54
3.4 Numerical experiments	55
3.5 Conclusions	65
4 Determination of the optimal dampers' positions	67

4.1	Optimization of dampers' positions	69
4.1.1	Determination of optimal damping for a one-dimensional case	72
4.2	The "Multigrid-like" optimization approach	75
4.3	The "Discrete to continuous" optimization approach	80
4.4	Damping optimization based on dimension reduction and con- tinuous minimization	84
4.5	Area with the optimal dampers' positions	89
4.5.1	Numerical experiments	93
4.6	Conclusions	98
5	Optimal damping of a system - a case study	99
5.1	Solution of a structured Lyapunov equation	102
5.2	Minimization of the trace of the solution of the Lyapunov equation	113
5.3	Numerical experiments	116
5.4	Conclusions	119
	Future research	121
	Bibliography	122
	Curriculum Vitae	128
	Summary	131

Acknowledgements

First, I would like to thank my supervisor Prof. Ninoslav Truhar for all his encouragement and help throughout the development of the work described in this thesis. He introduced me to an interesting problem of damping of linear vibrational systems. During research of this subject, he devoted to me a lot of his time throughout numerous informal discussions which contributed to my scientific and personal life.

I am thankful to my supervisor, Prof. Peter Benner, for his guidance and all of his valuable comments and discussions. During the last four years, several visits to his working group in TU-Chemnitz he made possible and the last visit was to the Max Planck Institute in Magdeburg. During these visits we were working intensively on techniques for dimension reduction.

Supervisor Prof. Zlatko Drmač, who was also my diploma supervisor, introduced me to a beautiful field of Numerical linear algebra for which I am sincerely grateful.

I would also like to thank Prof. Krešimir Veselić for valuable discussions related to the subject of the thesis.

Further, I am thankful to all my colleagues from the Department of Mathematics, University of Osijek, for their support and understanding.

I am deeply grateful to my parents Radoslava and Ivica and my brother Mladen, for all their support and encouragement throughout my life.

Finally, and most of all, I would like to thank my wife Anita and daughter Kalista for all support and love during my graduate and postgraduate study.

Prije svega, želio bih zahvaliti mentoru prof. Ninoslavu Truharu za pomoć i poticaj u procesu izrade disertacije. Prof. Truhar me je upoznao sa zanimljivim problemom prigušenja linearnih vibracijskih sustava. Tijekom istraživanja ove teme posvetio mi je puno vremena vodeći sa mnom brojne neformalne rasprave koje su mi pomogle u znanstvenom i osobnom životu.

Zahvaljujem mentoru prof. Peteru Benneru na njegovom vodstvu i vrijednim komentarima i raspravama. On mi je tijekom protekle četiri godine omogućio nekoliko posjeta svojoj radnoj grupi na TU-Chemnitz, a posljednji posjet bio je na Max Planck Institute u Magdeburgu. Tijekom tih posjeta intenzivno smo radili na tehnikama za redukciju dimenzije sustava.

Mentor prof. Zlatko Drmač bio je moj mentor i prilikom izrade diplomskog rada. Upoznao me s prekrasnim područjem numeričke linearne algebre na čemu sam mu iskreno zahvalan.

Želim zahvaliti i prof. Krešimiru Veseliću na korisnim razgovorima vezanim uz temu disertacije.

Nadalje, zahvaljujem svim kolegama s Odjela za matematiku, Sveučilišta u Osijeku, na njihovoj podršci i razumijevanju.

Duboko sam zahvalan svojim roditeljima Radoslavi i Ivici i bratu Mladenu, na podršci i poticaju tijekom cijelog mog života.

Na kraju, i najviše od svega, hvala mojoj supruzi Aniti i kćeri Kalisti na svojoj podršci i ljubavi za vrijeme diplomskog i poslijediplomskog studija.

Chapter 1

Introduction

1.1 Motivation

In real physical systems, which possess elasticity and mass, vibration is a typical phenomenon which was widely studied in the past, but also nowadays this is a widely investigated field.

Vibrations can sometimes be desirable. On the other hand, dangerous vibrations could produce damage or even a breakup of the vibrational system. For example, dangerous vibrations can lead to a collapse or structural damage of the bridge. A well known collapse of the bridge happened to the suspension bridge called Tacoma Narrows Bridge in November, 1940. One recent example of dangerous vibration of a bridge happened at the seven kilometer long bridge over the Volga River (the bridge was opened in 2009). The bridge had oscillations whose amplitude was reaching 1 meter. Appropriate damping of a system should be employed in order to prevent dangerous vibrations.

In relation to vibrational systems, damping is a widely studied problem. In real-world systems, energy is always dissipated by some means and damping is the dissipation of energy with time or distance. Damping can produce undesirable effects such as energy waste, noise or heat production. On the

other hand, damping is also responsible for many important system properties such as stability, control and that the amplitude of free vibrations, decays to a negligible value.

There are different types of damping which correspond to different real-world systems. An overview of various types of damping is presented in [43]. A mathematical introduction to damped oscillations of linear systems is given in [55]. There are also many other books that study vibrational systems and the problem of damping, such as [25; 26; 29; 30; 38; 47].

In terms of different types of damping, in this thesis we will refer to critical damping, internal damping, passive damping and viscous damping. Viscous damping is the dissipation of energy which happens when a particle in a vibrating system is resisted by a force. This force has a magnitude proportional to the magnitude of the velocity of the particle and a direction opposite to the direction of the particle. The main part of the thesis will be efficient determination of optimal external viscous damping for the given vibrational system. Critical damping is the minimum viscous damping that will ensure a return of a displaced system to its initial position without oscillation. Internal damping is a result of the mechanical energy dissipation within the material as a result of various microscopic and macroscopic processes.

Figure 1.1 shows a single degree-of-freedom system with a viscous damper. The differential equation of motion of mass $m > 0$ with the spring of stiffness $k > 0$ is

$$m\ddot{x} + c\dot{x} + kx = 0,$$

where $c > 0$ is viscosity.

The corresponding quadratic eigenvalue problem is

$$m\lambda^2 + c\lambda + k = 0,$$

with roots being equal to

$$\frac{-c \pm \sqrt{c^2 - 4km}}{2m}.$$

It is well known that the structure of the solution $x(t)$ depends on magnitudes of quantities m, c and k ($x(t)$ is the displacement from the equilibrium position). That is, with respect to the sign of the expression $c^2 - 4km$ we distinguish three cases:

- $c^2 - 4km < 0$, the system is "weakly damped",
- $c^2 - 4km > 0$, the system is "overdamped",
- $c^2 - 4km = 0$, the system is "critically damped"; in this case there is no oscillation at the solution x .

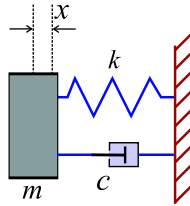

Figure 1.1: Single degree-of-freedom system with a viscous damper

In the next section we will set a general problem setting.

1.2 Problem formulation

We consider a mathematical model of a linear vibrational system described by the system of differential equations:

$$M\ddot{x} + D\dot{x} + Kx = 0, \quad (1.1)$$

where the matrices M and K (called mass and stiffness, respectively) are real symmetric positive definite matrices of order n . Matrix

$$D = C_u + C_{ext}$$

represents the damping matrix, where internal damping C_u is a symmetric positive semidefinite matrix. External viscous damping

$$C_{ext} = v_1 C_1 + v_2 C_2 + \cdots + v_k C_k$$

is a semidefinite matrix where C_i describes a geometry of the corresponding dampers' position with corresponding viscosity v_i for $i = 1, \dots, k$.

We will assume that our system is slightly modally damped which is a usual assumption when considering mechanical systems. Modally damped systems are characterized by the identity:

$$MK^{-1}C_u = C_u K^{-1}M. \quad (1.2)$$

For more details see [35; 38; 55; 59]. In [55] it is also shown that this assumption is a characterization of the systems with internal damping C_u such that triple (M, C_u, K) can be simultaneously diagonalized. Another characterization of the systems such that triple (M, C_u, K) is simultaneously diagonalizable is given in [1].

More precisely, throughout the thesis we will assume that internal damping C_u is a small multiple of critical damping, that is,

$$C_u = \alpha_c C_{crit}, \quad (1.3)$$

where critical damping is defined with

$$C_{crit} = 2M^{1/2}\sqrt{M^{-1/2}KM^{-1/2}}M^{1/2}. \quad (1.4)$$

This internal damping was widely used (for example see [14; 39; 50; 51; 53; 59]). Observe that C_u defined in Equation (1.3) satisfies congruence condition (1.2).

For the sake of simplicity, we will use parameter $\alpha = 2\alpha_c$. Moreover, it holds that $\Phi^T C_u \Phi = \alpha \Omega$, where Φ is a matrix that simultaneously diagonalizes M

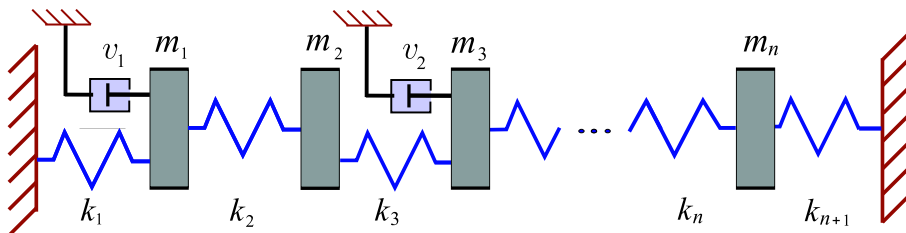

Figure 1.2: n -mass oscillator with two dampers of different viscosity

The system given in Figure 1.2, described by the above matrices M , D and K , corresponds to a discrete model for a vibrating string and also for a longitudinally vibrating elastic rod. For more details see for example [34].

Equation (1.1) can be transformed to the so-called phase space which yields a system of the first order differential equations. For that purpose let Φ be a matrix that simultaneously diagonalizes M and K , it holds

$$\Phi^T K \Phi = \Omega^2 = \text{diag}(\omega_1^2, \dots, \omega_n^2) \quad \text{and} \quad \Phi^T M \Phi = I. \quad (1.8)$$

Positive numbers $\omega_1, \omega_2, \dots, \omega_n$ are eigenvalues of the undamped system $M\ddot{x} + Kx = 0$, and they are called undamped eigenfrequencies.

Physical background and more details about the matrix Φ will be presented in Section 2.1.1.

Using the substitutions $x = \Phi x_\Phi$, $y_1 = \Omega x_\Phi$ and $y_2 = \dot{x}_\Phi$ we can write differential equation (1.1) in a phase space as

$$\frac{d}{dt} \begin{bmatrix} y_1 \\ y_2 \end{bmatrix} = \begin{bmatrix} 0 & \Omega \\ -\Omega & -\Phi^T D \Phi \end{bmatrix} \begin{bmatrix} y_1 \\ y_2 \end{bmatrix} \quad (1.9)$$

$$\text{or} \quad \dot{y} = Ay,$$

where

$$A = \begin{bmatrix} 0 & \Omega \\ -\Omega & -\Phi^T D \Phi \end{bmatrix}, \quad y = \begin{bmatrix} y_1 \\ y_2 \end{bmatrix}. \quad (1.10)$$

For more details see for example [14; 39; 52; 53].

Now, we have the first order differential equation

$$\dot{y} = Ay,$$

with the solution

$$y(t) = e^{At}y_0, \quad \text{where } y_0 \text{ contains the initial data.}$$

For (M, D, K) from our problem it can be shown that the matrix A is (asymptotically) stable or *Hurwitz*, that is, eigenvalues of A are in the left half of the complex plane, see [48].

In investigation of vibrating systems, we are interested in the following problem: for a given mass and stiffness we want to determine the "best" (optimal) damping matrix D which insures optimal evanescence of each component of y .

This problem requires a certain optimization criterion. One criterion is the so-called spectral abscissa criterion, which requires that the maximal real part of the eigenvalues of the corresponding quadratic eigenvalue problem is minimized. More precisely, the spectral abscissa is defined by

$$\mu(A) := \max_k \operatorname{Re} \lambda_k,$$

where λ_k is the complex eigenvalue of the corresponding quadratic eigenvalue problem

$$(\lambda^2 M + \lambda D + K)x = 0. \tag{1.11}$$

Then the spectral abscissa criterion is equivalent to minimization of $\mu(A)$. For more details about quadratic eigenvalue problem one can see for example [3; 48].

We will use another criterion which is based on the minimization of the total energy of the system:

$$\int_0^{\infty} E(t; y_0) dt \rightarrow \min, \quad (1.12)$$

where $E(t)$ is the total energy of the system at given time t (as a sum of kinetic and potential energy), more precisely

$$E(t; y_0) = \frac{1}{2} \dot{x}(t)^T M x(t) + \frac{1}{2} x(t)^T K x(t). \quad (1.13)$$

It can be shown that $\frac{1}{2} \dot{x}(t)^T M x(t) + \frac{1}{2} x(t)^T K x(t) = \frac{1}{2} \|y(t)\|^2$.

Criterion (1.12) depends on the initial data y_0 . In order to overcome this problem, we take the average over all initial states of the unit total energy. It can be shown [39; 56; 57] that with this averaging our criterion is equivalent to

$$\text{trace } X \rightarrow \min, \quad (1.14)$$

where X is the solution of the Lyapunov equation

$$AX + XA^T = -Z \quad (1.15)$$

with A as in (1.10). The existence of the unique solution X is ensured with the stability of the matrix A , see for example [22; 41]. The structure of the matrix Z determines which part of undamped eigenfrequencies has to be damped and the structure of the matrix Z has the following form

$$Z = GG^T. \quad (1.16)$$

The case when $G = I$ corresponds to the case when all eigenfrequencies of the undamped system are damped. If we are interested in damping of just first s eigenfrequencies of the undamped system (s of them corresponding to the

critical part), the matrix G will have the following form

$$G = \begin{bmatrix} I_s & 0 \\ 0 & 0 \\ 0 & I_s \\ 0 & 0 \end{bmatrix}. \quad (1.17)$$

The structure of Z has been studied in [39].

In [39], it is shown that our criterion (1.14) can be written using the solution of the so-called dual Lyapunov equation

$$A^T \widehat{X} + \widehat{X} A = -I. \quad (1.18)$$

Then, criterion (1.14) can be written as

$$\text{trace } \widehat{X} Z \rightarrow \min. \quad (1.19)$$

Considering the trace and the spectral abscissa criterion, in [59] authors state that very often optimization with the spectral abscissa criterion gives a similar result to optimization of the trace. However, they also give an example where the spectral abscissa may fail. Furthermore, the advantage of criterion (1.14) is its connection with the total energy of vibration. Also, the criterion with the trace implies a penalty function that is smooth, which is not the case for the spectral abscissa criterion, although there is a criterion which uses smoothed spectral criterion [54]. For more details about the spectral abscissa criterion see also [24]. Apart from these criterions, in damping optimization one can also use another criterions. One overview of the criterions with their descriptions is given in [39]. Criterion (1.14) will be used throughout this thesis.

The optimization problem (1.14) has been intensively considered in the last decade. Basically, there are two different approaches. One approach uses a formula for a corresponding solution of the Lyapunov equation and contrary to this approach are methods which include numerical approximations.

Explicit formulae for the trace, for linear vibrational systems with one-dimensional external damping and without internal damping, are given in [57]. The closest generalization of this approach is presented in Chapter 5. In [52] authors show that the trace of a corresponding Lyapunov equation can be represented as a rational function of viscosity. Moreover, an efficient algorithm which derives a formula for the trace of the solution of the Lyapunov equation is presented in paper [50]. In [50], N. Truhar considers the case where external damping has a rank greater than 1 and includes one viscosity (all dampers have the same viscosity).

Approaches which include different approximations were also widely studied. Modal approximations of damped linear systems are presented in [58]. In [53], authors present an approach that uses an iterative method (ADI method) for calculation of a low rank approximation of the solution of the corresponding Lyapunov equation. Approximation of the Lyapunov equation will be considered in this thesis in approaches which use dimension reduction techniques.

Furthermore, optimal damping was studied in thesis [14] by K. Brabender and in thesis [39], where I. Nakić considers this optimization problem and gives a generalization of criterion (1.14) to the infinite dimensional case. The existence and the uniqueness of the global minimum, using criterion (1.14), was proved in [21].

Damping optimization using criterion (1.14) requires solving the Lyapunov equation (1.15) numerous times (this will be presented in detail in Section 4.1). On the other hand, for larger n even solving the Lyapunov equation is very prohibitive. All this together makes the optimization process very demanding. We will consider different approaches in which our aim will be acceleration of the optimization process.

The main part of this thesis will be the construction of an efficient method for determination of optimal damping using dimension reduction. For that purpose we propose dimension reduction techniques in order to accelerate the optimization process. Our algorithms for an efficient approximation of optimal damping will be based on this approximation. We also give algorithms

for an efficient optimization of dampers' positions. Some of them use heuristic approaches which can be combined with algorithms which use dimension reduction techniques.

In the last chapter we will consider a case study for systems with a very strong structure. That is, for a system without internal damping we assume that the undamped eigenfrequencies $\omega_1, \omega_2, \dots, \omega_n$ (undamped eigenfrequencies are introduced in (1.8)), are double in pairs; more precisely it holds that $\omega_1 = \omega_2$, $\omega_3 = \omega_4, \dots, \omega_{n-1} = \omega_n$. In this case we present a formula which gives the solution of the corresponding Lyapunov equation (with an additional linear system of order $\frac{n}{2}$ which has to be solved), this then allows us to calculate the first and the second derivatives of the trace of the solution, with no extra costs. This one can serve for the efficient trace minimization. This is a generalization of the result from [57] where the similar explicit formulae for the trace are given.

Dimension reduction in applications is widely used. Systems with moderate or large dimension are usually approximated with the systems which have smaller dimension for the purpose of reducing complexity.

There is a lot of algorithms which use dimension reduction of second-order systems. Dimension reduction methods were examined using balancing methods and model reduction techniques in [10; 19; 20; 37; 42]. This problem was also considered using Krylov-based methods in [4; 6; 36]. Several methods for dimension reduction were also given in [2; 3; 9]. Besides the dimension reduction techniques presented in this thesis, we have considered several model reduction methods based on the existing approaches (some of them are mentioned in the above references). Unfortunately, application of these methods is not straightforward applicable to our optimization problem. In this thesis we will consider new approaches.

Some approaches which use dimension reduction with optimization criterion (1.14) are presented in [59] where authors use frequency cut off and the so-called modal approximation. Some of these techniques were also studied in [51] where authors also give a heuristic algorithm for determination of optimal

positions of dampers. The main disadvantage of these approaches is that there is no theoretical justification for these approximations, thus we will present dimension reduction techniques with corresponding error bounds.

1.3 Organization of the thesis

In this section we present an organization of this thesis.

Chapter 2: Optimal damping of all eigenfrequencies using dimension reduction

This chapter is devoted to a case where all eigenfrequencies of the undamped system have to be damped. In Section 2.1, we explain the basic idea of dimension reduction. We also note the connection of dimension reduction with physical properties of the system. Generally, our approximation strategy for the solution of the Lyapunov equation is presented in Section 2.2. For this approximation we give a corresponding error bound in Section 2.3. Relying on the approximation and the corresponding error bound we present a method for calculation of optimal viscosities in Section 2.4. Numerical examples are presented in Section 2.5. Section 2.6 contains conclusions.

Some results presented in this chapter are also available in [12]:

P. Benner, Z. Tomljanović, and N. Truhar, Dimension reduction for damping optimization in linear vibrating systems, *Z. Angew. Math. Mech.* 91 (2011), no. 3, 179–191, DOI: 10.1002/zamm.201000077.

Chapter 3: Optimal damping of selected eigenfrequencies using dimension reduction

In this chapter we are interested in damping of selected undamped eigenfrequencies. In Section 3.1, we will present an algorithm for approximation of the trace of the solution of the Lyapunov equation. The corresponding error

bound for trace approximation of the solution of the Lyapunov equation is given in Section 3.2. Using the approximation algorithm, in Section 3.3, we give an algorithm for approximation of optimal viscosities. A comparison of the new algorithm with the current standard algorithm for viscosity optimization is given in numerical examples in Section 3.4. Conclusions are discussed in Section 3.5.

Some results presented in Chapter 3 and Section 4.5 are also available in [13]:

P. Benner, Z. Tomljanović, and N. Truhar, Optimal damping of selected eigenfrequencies using dimension reduction, submitted for publication in NLAA, 2011.

Chapter 4: Determination of the optimal dampers' positions

Here we study an efficient calculation of optimal damping which includes optimal viscosities and we are especially interested in optimal dampers' positions. In Section 4.1, we present the "Direct" approach which searches through all dampers' positions and two heuristical approaches; the "Multigrid-like" and the "Discrete to continuous" optimization approaches are described in sections 4.2 and 4.3, respectively. The optimization approach, which combines dimension reduction techniques with heuristical approaches for position optimization, is given in Section 4.4. The dimension reduction approach can be applied for determination of the area that contains the optimal dampers' positions, which is presented in Section 4.5. Conclusions are presented in Section 4.6.

Some results presented in this chapter are also available in [11], [51]:

P. Benner, Z. Tomljanović, and N. Truhar, Damping optimization in linear vibrating systems using dimension reduction, accepted for publication in Proceedings of the 10th International Conference on Vibration Problems, Prague.

N. Truhar and Z. Tomljanović, Estimation of optimal damping for mechanical vibrating systems, *Intl. J. Appl. Math. Mech.* 5 (2009), no. 5, 14–26.

Chapter 5: Optimal damping of a system - a case study

This chapter is devoted to the case study of the system with a special structure, where all undamped eigenfrequencies are double in pairs. That is, $\omega_1 = \omega_2$, $\omega_3 = \omega_4$, \dots , $\omega_{n-1} = \omega_n$. In Section 5.1, we derive a formula for the solution of the structured Lyapunov equation. Section 5.2 is devoted to trace minimization using the new formula, whereas Section 5.3 contains numerical experiments and comparison with existing algorithms. Conclusions are given in Section 5.4.

Some results presented in this chapter are also available in [49]:

Z. Tomljanović, N. Truhar, and K. Veselić, Optimizing a damped system - a case study, *International Journal of Computer Mathematics* 88 (2011), no. 7, 1533–1545, DOI: 10.1080/00207160.2010.521547, 2011 (iFirst).

Notation

In this thesis we will use the following notation:

$\ \cdot\ $	the standard 2-norm;
$\ \cdot\ _F$	the Frobenius norm;
\otimes	the Kronecker product;
$ A $	the matrix with (i, j) element being equal to $ a_{ij} $;
$A(p, q)$	the submatrix of A obtained by intersection of rows determined with vector p and columns determined with vector q ;
$A(:, i)$	the i th column of matrix A ;
$A(i, :)$	the i th row of matrix A ;
d^{-T}	denotes $(d^{-1})^T$;
$\text{diag}(d_1, \dots, d_n)$	the diagonal matrix with diagonal entries d_1, \dots, d_n ;
$i : j$	the vector of integers from i to j ;
I_s	the s -dimensional identity matrix;
\mathbb{R}_+	the set $\{x \in \mathbb{R} : x \geq 0\}$;
$\text{trace}(X)$	the trace of matrix X .

The notations $A(p, q)$, $i : j$, $A(:, i)$, $A(i, :)$ are taken from MATLAB®.

Chapter 2

Optimal damping of all eigenfrequencies using dimension reduction

In this chapter, we will consider the construction of an efficient algorithm for calculation of optimal damping for the case where all undamped eigenfrequencies have to be damped.

Using the structure of our system:

$$M\ddot{x} + D\dot{x} + Kx = 0, \tag{2.1}$$

we will derive an approximation of the solution of the corresponding Lyapunov equation and an error bound for this approximation. Our algorithm for efficient approximation of optimal damping is based on this approximation. Numerical results illustrate the effectiveness of our approach.

Since we are interested in damping of all undamped eigenfrequencies, the

matrix Z from Lyapunov equation (1.15) is equal to identity and the corresponding Lyapunov equation is equal to

$$AX + XA^T = -I, \quad A = \begin{bmatrix} 0 & \Omega \\ -\Omega & -\Phi^T D \Phi \end{bmatrix}, \quad (2.2)$$

where Φ is a matrix which simultaneously diagonalizes pair (M, K) , that is,

$$\Phi^T K \Phi = \Omega^2 = \text{diag}(\omega_1^2, \dots, \omega_n^2) \quad \text{and} \quad \Phi^T M \Phi = I.$$

Matrix $D = C_u + C_{ext}$ is a damping matrix from the system described by Equation (2.1), where for internal damping we have that $\Phi^T C_u \Phi = \alpha \Omega$.

In our approach we construct two truncation matrices Q_1 and Q_2 such that system (2.1) can be approximated with two systems of a smaller dimension. These systems are

$$M_r^i \ddot{y}_i + D_r^i \dot{y}_i + K_r^i y_i = 0, \quad (2.3)$$

where $x_i = Q_i y_i$ and

$$\begin{aligned} M_r^i &= Q_i^T M Q_i, \\ D_r^i &= Q_i^T D Q_i, \\ K_r^i &= Q_i^T K Q_i \quad \text{for } i = 1, 2. \end{aligned}$$

An $n \times r$ matrix Q_1 is a full column rank matrix which will give a reduced system, such that contribution to the trace of the Lyapunov equation can be calculated by solving the Lyapunov equation of smaller dimension $2r \times 2r$ ($r < n$). Furthermore, matrix Q_2 is an $n \times (n - r)$ full column rank matrix, which will in the linearization form give a block diagonal matrix, thus contribution to the corresponding trace of the Lyapunov equation of the system can be calculated by a simple formula.

2.1 Solving Lyapunov equations using dimension reduction: basic idea

The structure of the Lyapunov equation has an important impact on dimension reduction, thus we will first discuss the structure of the considered Lyapunov equation (2.2).

For this we will need a perfect shuffle permutation matrix. Perfect shuffle permutation is the permutation that splits a set into 2 piles and interleaves them. More precisely, it is defined with permutation which maps

$$k \mapsto \begin{cases} 2k - 1, & k \leq n, \\ 2(k - n), & k > n, \end{cases}$$

for $k = 1, 2, \dots, 2n$.

After multiplying by perfect shuffle permutation we obtain the following Lyapunov equation

$$A_P X_P + X_P A_P^T = -I, \quad (2.4)$$

where

$$A_P = A_0 + P^T \begin{bmatrix} 0 & 0 \\ 0 & C \end{bmatrix} P, \quad C = \Phi^T C_{ext} \Phi, \quad (2.5)$$

$$A_0 = \hat{A}_1 \oplus \hat{A}_2 \oplus \dots \oplus \hat{A}_n, \quad \hat{A}_i = \begin{bmatrix} 0 & \omega_i \\ -\omega_i & -\alpha\omega_i \end{bmatrix}, \quad (2.6)$$

$$X_P = P^T X P.$$

Our approach uses a simple fact that if $C_{ext} = 0$, then the solution of the Lyapunov equation (2.4) is given by

$$X_P = \hat{X}_1 \oplus \hat{X}_2 \oplus \dots \oplus \hat{X}_n,$$

where

$$\widehat{X}_i = \frac{1}{\omega_i} \begin{bmatrix} \frac{2+\alpha^2}{2\alpha} & -\frac{1}{2} \\ -\frac{1}{2} & \frac{1}{\alpha} \end{bmatrix} \quad \text{and} \quad \text{trace}(\widehat{X}_i) = \left(\frac{2}{\alpha} + \frac{\alpha}{2} \right) \frac{1}{\omega_i}. \quad (2.7)$$

Now, since P is a permutation matrix and $C_{ext} = 0$, we can easily calculate the trace of the Lyapunov equation (2.2). It holds

$$\text{trace } X = \text{trace } X_P = \left(\frac{2}{\alpha} + \frac{\alpha}{2} \right) \sum_{i=1}^n \frac{1}{\omega_i}. \quad (2.8)$$

Moreover, if $C_{ext} \neq 0$, the matrix A_P from Equation (2.5) has the following form:

$$A_P = \begin{bmatrix} 0 & \omega_1 & 0 & 0 & 0 & 0 & \cdots & 0 & 0 \\ -\omega_1 & -\alpha\omega_1 - c_{11} & 0 & -c_{12} & 0 & -c_{13} & \cdots & 0 & -c_{1n} \\ 0 & 0 & 0 & \omega_2 & 0 & 0 & \cdots & 0 & 0 \\ 0 & -c_{12} & -\omega_2 & -\alpha\omega_2 - c_{22} & 0 & -c_{23} & \cdots & 0 & -c_{2n} \\ 0 & 0 & 0 & 0 & 0 & \omega_3 & \cdots & 0 & 0 \\ 0 & -c_{13} & 0 & -c_{23} & -\omega_3 & -\alpha\omega_3 - c_{33} & \cdots & 0 & -c_{3n} \\ \vdots & \vdots & \vdots & \vdots & \vdots & \vdots & \ddots & \vdots & \vdots \\ 0 & 0 & 0 & 0 & 0 & 0 & \cdots & 0 & \omega_n \\ 0 & -c_{1n} & 0 & -c_{2n} & 0 & -c_{3n} & \cdots & -\omega_n & -\alpha\omega_n - c_{nn} \end{bmatrix},$$

where $c_{ij} = (C)_{ij}$, C is given in (2.5). Note that since C_{ext} is a symmetric matrix, the matrix C is also a symmetric matrix.

Let us illustrate our main idea on the following example. If some part of the matrix C has "small norm", then we will approximate A_p with \widetilde{A}_p neglecting that part. For example, if $\|C(:, r+1 : n)\|$ is small, then matrix A_P from (2.5) will be approximated by

$$\widetilde{A}_P = \begin{bmatrix} \widetilde{A}_{11} & 0 \\ 0 & \widetilde{A}_{22} \end{bmatrix}, \quad (2.9)$$

where

$$\tilde{A}_{11} = A_P(1 : 2r, 1 : 2r) \quad \text{and} \quad \tilde{A}_{22} = \hat{A}_{r+1} \oplus \cdots \oplus \hat{A}_n, \quad (2.10)$$

and \hat{A}_i is defined in (2.6). Using this approximation, the solution of the Lyapunov equation (2.4) can be approximated by the solution of the Lyapunov equation

$$\tilde{A}_P \tilde{X}_P + \tilde{X}_P \tilde{A}_P^T = -I, \quad (2.11)$$

where \tilde{A}_P is given by Equation (2.9) and for the solution we have a block structure

$$\tilde{X}_P = \begin{bmatrix} X_{11} & 0 \\ 0 & X_{22} \end{bmatrix}.$$

The upper block-diagonal part X_{11} is the solution of the Lyapunov equation

$$\tilde{A}_{11} X_{11} + X_{11} \tilde{A}_{11}^T = -I, \quad (2.12)$$

and the lower block-diagonal part is the solution of the

$$\tilde{A}_{22} X_{22} + X_{22} \tilde{A}_{22}^T = -I, \quad (2.13)$$

due to the block structure of \tilde{A}_{22} we have that $X_{22} = \hat{X}_{r+1} \oplus \cdots \oplus \hat{X}_n$ where \hat{X}_i is from (2.7).

Note that in terms of truncation matrices Q_i , introduced in Equation (2.3), the above Lyapunov equations can be obtained using appropriate truncation matrices (up to the perfect shuffle permutation). That is, the Lyapunov equation (2.12) can be obtained from the system (2.3) using $Q_1 = \Phi(:, 1 : r)$, while Lyapunov equation (2.13) can be obtained from the system (2.3) using $Q_2 = \Phi(:, r + 1 : n)$ and setting that $\|C(:, r + 1 : n)\| = \|C(r + 1 : n, :)\| = 0$ (which is by our assumption small by the norm).

Since we are particularly interested in the trace of the solution of the Lyapunov equation (2.2), using the formula (2.7) we have the following approximation

$$\text{trace } X = \text{trace } X_P \approx \text{trace } \tilde{X}_P = \text{trace } X_{11} + \left(\frac{2}{\alpha} + \frac{\alpha}{2} \right) \sum_{i=r+1}^n \frac{1}{\omega_i},$$

where X_{11} is the solution of Equation (2.12). Since we have to solve the Lyapunov equation with matrices of dimension $2r \times 2r$ (in order to obtain X_{11}), we can see that the dimension of the reduced system is connected with the magnitude of the elements in the matrix C , thus in the next subsection we will show that this is closely related with the structure of the considered system.

2.1.1 Connection of small elements in damping with the structure of the matrix Φ

The primary question in this subsection is: *when can we expect that the norm of some part of the matrix C will be small?*

As we have mentioned in the previous section, instead of solving Lyapunov equation (2.4) we will solve its approximation with matrices of dimension $2r \times 2r$. The dimension r depends on the magnitude of the absolute values of the entries of the matrix $C = \Phi^T C_{ext} \Phi$. This means that the dimension of the reduced system (dimension r) is determined by magnitude of elements in the matrix C which is closely related to the magnitude of the elements in the matrix Φ (which is usually called the modal matrix).

Furthermore, the elements of the matrix Φ are closely related to displacements of the masses at the corresponding modes. Particularly, the i th mode of the system is determined by the i th column of the matrix Φ . For each mode, mass displacements are sinusoidal with the same frequency, and the extreme value of displacement for the i th mode at the k th mass is equal to Φ_{ki} . The i th column of the matrix Φ is called the i th natural mode (or the i th mode

shape) and corresponds to the i th natural frequency (or the i th undamped eigenfrequency). For more details see for example [26; 43].

As an illustrative example consider the mechanical system shown in Figure 1.2. If we add one damper at position k with viscosity v (thus the second viscosity $v_2 = 0$). This means that $C = \Phi^T C_{ext} \Phi = v \Phi^T e_k e_k^T \Phi$ and $c_{ij} = v \phi_{ki} \phi_{kj}$ where $\phi_{ij} = (\Phi)_{ij}$.

On the other hand, the first part of Figure 2.1 shows the corresponding undamped system in the equilibrium stage. The second part presents the system with displacements which corresponds to the i th mode. From this part we can conclude that if some masses are larger than the others, the corresponding displacements will be smaller. That justifies our assumption that some entries of the matrix C will be small, indeed since $c_{ij} = v \phi_{ki} \phi_{kj}$ for small ϕ_{ki} and ϕ_{kj} , c_{ij} will be small, too. As a small illustration which also testifies our assumption, we consider the system from Figure 2.1 with 5 masses ($n = 5$) and the following configuration:

$$\begin{aligned} m_1 &= 1, m_2 = 5, m_3 = 10, m_4 = 30, m_5 = 50; \\ k_i &= 1, i = 1, \dots, 6. \end{aligned}$$

For this configuration the mass and the stiffness matrix are:

$$\begin{aligned} M &= \text{diag}(1, 5, 10, 30, 50), \\ K &= \begin{bmatrix} 2 & -1 & 0 & 0 & 0 \\ -1 & 2 & -1 & 0 & 0 \\ 0 & -1 & 2 & -1 & 0 \\ 0 & 0 & -1 & 2 & -1 \\ 0 & 0 & 0 & -1 & 2 \end{bmatrix}. \end{aligned}$$

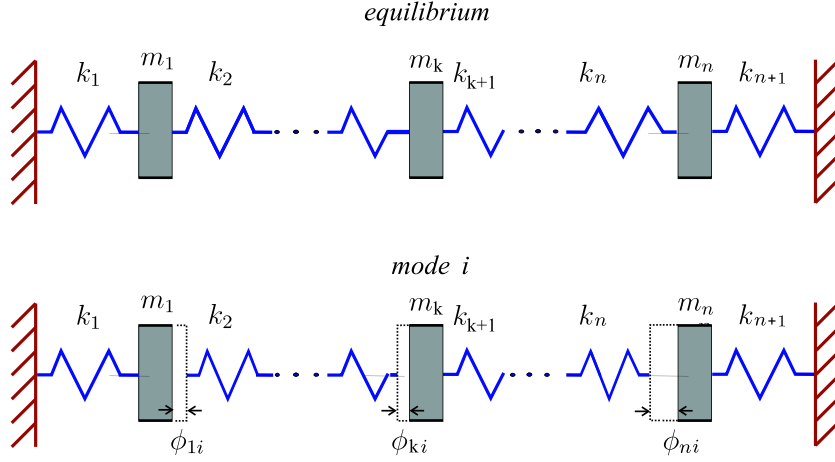

Figure 2.1: Displacements for the i th mode are shown at their extreme values

It is easy to calculate that

$$\Phi = \begin{bmatrix} -3.6751 \cdot 10^{-2} & -5.6613 \cdot 10^{-2} & 1.2451 \cdot 10^{-1} & -2.1099 \cdot 10^{-1} & -9.6717 \cdot 10^{-1} \\ -7.3017 \cdot 10^{-2} & -1.1008 \cdot 10^{-1} & 2.3254 \cdot 10^{-1} & -3.45 \cdot 10^{-1} & 1.1334 \cdot 10^{-1} \\ -1.0445 \cdot 10^{-1} & -1.3298 \cdot 10^{-1} & 1.8664 \cdot 10^{-1} & 1.9114 \cdot 10^{-1} & -5.9166 \cdot 10^{-3} \\ -1.2206 \cdot 10^{-1} & -8.2029 \cdot 10^{-2} & -1.0634 \cdot 10^{-1} & -1.9926 \cdot 10^{-2} & 9.6196 \cdot 10^{-5} \\ -9.1207 \cdot 10^{-2} & 1.0559 \cdot 10^{-1} & 2.3022 \cdot 10^{-2} & 1.1441 \cdot 10^{-3} & -9.2621 \cdot 10^{-7} \end{bmatrix}.$$

Now, we can calculate the matrix C for the given damper's position. For example, let the damper's position be at position 5, that is $k = 5$ and viscosity $v = 100$. Then we have:

$$C = 100 \cdot \Phi^T e_5 e_5^T \Phi = \begin{bmatrix} 8.3187 \cdot 10^{-1} & -9.6309 \cdot 10^{-1} & -2.0997 \cdot 10^{-1} & -1.0435 \cdot 10^{-2} & 8.4477 \cdot 10^{-6} \\ -9.6309 \cdot 10^{-1} & 1.1150 & 2.4309 \cdot 10^{-1} & 1.2081 \cdot 10^{-2} & -9.7802 \cdot 10^{-6} \\ -2.0997 \cdot 10^{-1} & 2.4309 \cdot 10^{-1} & 5.2999 \cdot 10^{-2} & 2.6339 \cdot 10^{-3} & -2.1323 \cdot 10^{-6} \\ -1.0435 \cdot 10^{-2} & 1.2081 \cdot 10^{-2} & 2.6339 \cdot 10^{-3} & 1.3090 \cdot 10^{-4} & -1.0597 \cdot 10^{-7} \\ 8.4477 \cdot 10^{-6} & -9.7802 \cdot 10^{-6} & -2.1323 \cdot 10^{-6} & -1.0597 \cdot 10^{-7} & 8.5787 \cdot 10^{-11} \end{bmatrix}.$$

We can see that in the above matrix C we have elements small by magnitude, and this effect is even bigger for larger dimensions.

Based on the ideas presented in Section 2.1, in the next section, we will show how one can find an approximate solution of the Lyapunov equation (2.2) in general.

2.2 Solving Lyapunov equations using dimension reduction: general case

In this section we will present an algorithm for the approximation of the solution of the Lyapunov equation (2.2) in a general case.

Let $\bar{p} \in \mathbb{N}^{n-r}$ be a vector of indices for which $n-r$ is the maximal (r is minimal) dimension such that $\|C(\bar{p}, :)\|_F$ is less than or equal to some tolerance tol . The vector of indices $p \in \mathbb{N}^r$ is chosen such that $p \cup \bar{p} = \{1, 2, \dots, n\}$. Then we define the vector $w \in \mathbb{N}^n$ with $w(i) = p(i)$ for $i = 1, \dots, r$ and $w(i) = \bar{p}(i-r)$ for $i = r+1, \dots, n$.

Instead of Lyapunov equation (2.4) we add additional permutation matrix \hat{P} and solve the following Lyapunov equation

$$\hat{P}^T A_P \hat{P} \hat{X}_P + \hat{X}_P \hat{P}^T A_P^T \hat{P} = -I, \quad (2.14)$$

where for solution \hat{X}_p it holds that $\hat{X}_p = \hat{P}^T X_P \hat{P}$ and the matrix \hat{P} is the permutation such that $\hat{P}(:, 2i-1 : 2i) = I(:, w(2i-1) : w(2i))$ for $i = 1, 2, \dots, n$. Moreover, with such permutation \hat{P} , the matrix $\hat{P}^T A_P \hat{P}$ has the following structure:

$$\hat{A}_P = \hat{P}^T A_P \hat{P} = \begin{bmatrix} 0 & \omega_{w(1)} & \cdots & 0 & 0 \\ -\omega_{w(1)} & -\alpha\omega_{w(1)} - c_{w(1)w(1)} & \cdots & 0 & -c_{w(1)w(n)} \\ \vdots & \vdots & \ddots & \vdots & \vdots \\ 0 & 0 & \cdots & 0 & \omega_{w(n)} \\ 0 & -c_{w(1)w(n)} & \cdots & -\omega_{w(n)} & -\alpha\omega_{w(n)} - c_{w(n)w(n)} \end{bmatrix}. \quad (2.15)$$

Since \widehat{P} is the permutation matrix, it holds that $\text{trace } \widehat{X}_P = \text{trace } X$, where X is the solution of (2.2) and \widehat{X}_P is the solution of the Lyapunov equation (2.14).

Now, with additional permutation \widehat{P} we have ensured the same structure needed in Section 2.1. Thus, we can use a similar approach, which includes neglecting of diagonal blocks "small by the norm". That is, approximation of the Lyapunov equation can be obtained from the following Lyapunov equation

$$\widetilde{A}_P \widetilde{X}_P + \widetilde{X}_P \widetilde{A}_P^T = -I,$$

where

$$\widetilde{A}_P = \begin{bmatrix} \widetilde{A}_{11} & 0 \\ 0 & \widetilde{A}_{22} \end{bmatrix} \quad \text{with} \quad \begin{aligned} \widetilde{A}_{11} &= \widehat{A}_P(1 : 2r, 1 : 2r), \\ \widetilde{A}_{22} &= \widehat{A}_{\overline{p}(1)} \oplus \cdots \oplus \widehat{A}_{\overline{p}(n-r)}, \end{aligned} \quad (2.16)$$

and \widehat{A}_i is defined by (2.6) while \widehat{A}_P is given by (2.15).

Then, approximation of the solution of the Lyapunov equation (2.2) is given by

$$\widetilde{X}_P = \begin{bmatrix} X_{11} & 0 \\ 0 & X_{22} \end{bmatrix}.$$

Here X_{11} and X_2 are the solutions of the Lyapunov equations

$$\widetilde{A}_{11} X_{11} + X_{11} \widetilde{A}_{11}^T = -I, \quad (2.17)$$

$$\widetilde{A}_{22} X_{22} + X_{22} \widetilde{A}_{22}^T = -I, \quad (2.18)$$

respectively. Solution of Equation (2.18) is given by $X_{22} = \widehat{X}_{\overline{p}(r+1)} \oplus \cdots \oplus \widehat{X}_{\overline{p}(n)}$ where matrices \widehat{X}_i are from (2.7). Thus, the trace of X_{22} can be obtained by a close formula for which we need $\mathcal{O}(n - r)$ flops, while for X_{11} we need to solve the Lyapunov equation with matrices of dimension $2r \times 2r$.

Similarly to Section 2.1, Lyapunov equation (2.17) can be obtained from the system (2.3) using an appropriate truncation matrix. Equation (2.17) corresponds to the Lyapunov equation which is obtained from the reduced system

(2.3) using the truncation matrix $Q_1 = \Phi(:, p)$. Now X_{22} is the solution which corresponds to the Lyapunov equation obtained from the system (2.3) using $Q_2 = \Phi(:, \bar{p})$ and setting $\|C(:, \bar{p})\| = \|C(\bar{p}, :)\| = 0$ (in our approach the corresponding part of the matrix C is small by the norm).

Since we are interested in the trace of the solution of the Lyapunov equation (2.2) or (2.14), we have

$$\text{trace } X = \text{trace } \tilde{X}_P \approx \text{trace } X_{11} + \left(\frac{2}{\alpha} + \frac{\alpha}{2} \right) \sum_{i=1}^{n-r} \frac{1}{\omega_{\bar{p}(i)}}, \quad (2.19)$$

where X_{11} is the solution of the Lyapunov equation (2.17).

As can be seen from Equation (2.19), the approximation of the trace X is obtained by summing the trace of the solution of the Lyapunov equation (2.17) obtained from the reduced system and the trace of the solution of the Lyapunov equation (2.18) (here we have used formula (2.7)). From the computational point of view, the most expensive part is solving the Lyapunov equation (2.17). By summarizing, we have reduced the problem of solving a $2n \times 2n$ Lyapunov equation to the problem of solving a Lyapunov equation of dimension $2r \times 2r$. In this sense the parameter r will be called the reduced dimension. The resulting method is presented in Algorithm 2.2.1.

Note that in the optimization process for viscosity optimization we only need the trace X instead of the solution X . Thus, for viscosity optimization, instead of Steps 5 and 6 of Algorithm 2.2.1 we will use the formula $\text{trace } X = \text{trace } X_{11} + \left(\frac{2}{\alpha} + \frac{\alpha}{2} \right) \sum_{i=1}^{n-r} \frac{1}{\omega_{\bar{p}(i)}}$.

In the following section we will derive an error bound for the approximation of the solution of the Lyapunov equation (2.2) obtained by the previous algorithm.

Algorithm 2.2.1 (Approximation of the solution of the Lyapunov equation (2.2))

Input: α, tol ;

Φ such that $\Phi^T K \Phi = \Omega^2 = \text{diag}(\omega_1^2, \dots, \omega_n^2)$ and $\Phi^T M \Phi = I$;

C – contains information about the dampers' positions and viscosities.

Output: $X(C)$

- 1: Determine minimal r and vector $\bar{p} \in \mathbb{N}^{n-r}$ such that $\|C(\bar{p}, :)\|_F < tol$, $i = 1, \dots, n - r$.
- 2: Determine vector $p \in \mathbb{N}^r$ such that $p \cup \bar{p} = \{1, 2, \dots, n\}$.
- 3: $\Omega_r = \text{diag}(\omega_{p(1)}, \omega_{p(2)}, \dots, \omega_{p(r)})$.
- 4: Calculate X_{11} , where

$$A_{11}X_{11} + X_{11}A_{11}^T = -I, \quad A_{11} = \begin{bmatrix} 0 & \Omega_r \\ -\Omega_r & -\alpha\Omega_r - C(p, p) \end{bmatrix}.$$

- 5: $\tilde{X}_P = X_{11} \oplus \hat{X}_{\bar{p}(r+1)} \oplus \dots \oplus \hat{X}_{\bar{p}(n)}$, where \hat{X}_i is given in (2.7).
- 6: $X(C) = P\hat{P}\tilde{X}_P\hat{P}^T P^T$, where the matrix P is the perfect shuffle permutation and the permutation matrix \hat{P} is introduced in (2.14).

2.3 Error bound

Since Algorithm 2.2.1 gives an approximation of the solution X of the Lyapunov equation (2.14), we are interested in the error bound for this approximation. For that purpose consider the Lyapunov equation (2.14) in the partitioned form

$$\begin{bmatrix} A_{11} & \varepsilon E \\ \varepsilon E^T & A_{22} \end{bmatrix} \begin{bmatrix} X_{11} & X_{12} \\ X_{12}^T & X_{22} \end{bmatrix} + \begin{bmatrix} X_{11} & X_{12} \\ X_{12}^T & X_{22} \end{bmatrix} \begin{bmatrix} A_{11}^T & \varepsilon E \\ \varepsilon E^T & A_{22}^T \end{bmatrix} = -I,$$

where $A = \begin{bmatrix} A_{11} & \varepsilon E \\ \varepsilon E^T & A_{22} \end{bmatrix}$, $X = \begin{bmatrix} X_{11} & X_{12} \\ X_{12}^T & X_{22} \end{bmatrix}$, $\varepsilon = \|A_{12}\|_F$ and $E = \frac{1}{\|A_{12}\|_F} \cdot A_{12}$.

By equalizing the corresponding blocks we obtain

$$A_{11}X_{11} + X_{11}A_{11}^T = -I - \varepsilon(EX_{12}^T + X_{12}E^T), \quad (2.20)$$

$$A_{22}X_{22} + X_{22}A_{22}^T = -I - \varepsilon(E^T X_{12} + X_{12}^T E), \quad (2.21)$$

$$A_{11}X_{12} + X_{12}A_{22}^T = -\varepsilon(EX_{22} + X_{11}E). \quad (2.22)$$

Since equations (2.20) – (2.22) can be considered as perturbed Sylvester equations, we will need a perturbation bound for Sylvester equations of the form $AX - XB = C$.

For our purpose we will use one from [32; 33]: let

$$(A + \Delta A)(X + \Delta X) - (X + \Delta X)(B + \Delta B) = C + \Delta C$$

be a perturbed equation. Then the following bound holds

$$\|\Delta X\|_F \leq \sqrt{3}\|\mathcal{P}^{-1}\|((\alpha + \beta)\|X\|_F + \gamma)\eta, \quad (2.23)$$

where $\mathcal{P} = I \otimes A - B^T \otimes I$ and $\eta = \max \left\{ \frac{\|\Delta A\|_F}{\alpha}, \frac{\|\Delta B\|_F}{\beta}, \frac{\|\Delta C\|_F}{\gamma} \right\}$, while α , β and γ are scaling factors as in [33]. Usually one uses $\alpha = \|A\|_F$, $\beta = \|B\|_F$, and $\gamma = \|C\|_F$, but some other constants for α, β and γ can be used as well.

Note that

$$\|\mathcal{P}^{-1}\| = \text{sep}(A, B)^{-1}, \quad (2.24)$$

where $\text{sep}(A, B)$ is the separation of matrices A and B defined as

$$\text{sep}(A, B) = \min_{X \neq 0} \frac{\|AX - XB\|_F}{\|X\|_F}.$$

First, we will derive the bound for the solution X_{12} of the Sylvester equation (2.22). In our case we have $A_{11} = \tilde{A}_{11}$ and $A_{22} = \tilde{A}_{22} + \Delta A_{22}$ with \tilde{A}_{22} and \tilde{A}_{11} given in (2.16) and

$$\Delta A_{22} = \hat{A}_P(2r + 1 : n, 2r + 1 : n) - \tilde{A}_{22},$$

where \widehat{A}_P is defined as in (2.15). Note that there is no perturbation in the matrix A_{11} , thus $\Delta A_{11} = 0$. Since ε is small, Equation (2.22) is a perturbation of the equation

$$A_{11}\widetilde{X}_{12} + \widetilde{X}_{12}\widetilde{A}_{22}^T = 0,$$

with solution $\widetilde{X}_{12} = 0$. Using the bound (2.23) one can obtain a bound for $X_{12} = \widetilde{X}_{12} + \Delta X_{12}$ with $\eta_1 = \max \left\{ \frac{\|\Delta A_{22}\|_F}{\|\widetilde{A}_{22}\|_F}, \frac{\|\varepsilon(E X_{22} + X_{11} E)\|_F}{\gamma} \right\}$, where γ is an arbitrarily small constant (since the right hand side of Equation (2.22) is zero): it holds

$$\|X_{12}\|_F = \|\Delta X_{12}\|_F \leq \sqrt{3}\|P_1^{-1}\|\eta_1\gamma,$$

where $P_1 = I \otimes A_{11} + \widetilde{A}_{22} \otimes I$. Since $\|E\|_F = 1$, using the triangle inequality we have

$$\eta_1 \leq \max \left\{ \frac{\|\Delta A_{22}\|_F}{\|\widetilde{A}_{22}\|_F}, \varepsilon \frac{\|X_{22}\|_F + \|X_{11}\|_F}{\gamma} \right\}.$$

Setting γ small enough yields

$$\eta_1 \leq \varepsilon \frac{\|X_{22}\|_F + \|X_{11}\|_F}{\gamma},$$

thus we obtain

$$\|X_{12}\|_F = \|\widetilde{X}_{12} + \Delta X_{12}\|_F = \|\Delta X_{12}\|_F \leq \sqrt{3}\|P_1^{-1}\|(\|X_{22}\|_F + \|X_{11}\|_F)\varepsilon. \quad (2.25)$$

Furthermore, we will derive a relative perturbation bound for the Lyapunov equation (2.20). Note that Equation (2.20) can be considered as a perturbation of the Lyapunov equation $A_{11}\widetilde{X}_{11} + \widetilde{X}_{11}A_{11}^T = -I$ with $X_{11} = \widetilde{X}_{11} + \Delta X_{11}$. Since there is no perturbation in A_{11} , in (2.23) we set $\alpha = \beta = 0$ and $\gamma = \|I\|_F = \sqrt{n}$. Then (2.23) yields

$$\begin{aligned} \|\Delta X_{11}\|_F &\leq \sqrt{3}\|P_2^{-1}\|\|\varepsilon(E X_{12}^T + X_{12} E)\|_F \\ &\leq 2\sqrt{3}\|P_2^{-1}\|\|X_{12}\|_F \varepsilon, \end{aligned} \quad (2.26)$$

where $P_2 = I \otimes A_{11} + A_{11} \otimes I$.

Now, from (2.24), (2.25) and (2.26) it follows

$$\frac{\|\Delta X_{11}\|_F}{\|X_{11}\|_F + \|X_{22}\|_F} \leq 6 \frac{1}{\text{sep}(A_{11}, -\tilde{A}_{22}^T)} \frac{1}{\text{sep}(A_{11}, -A_{11}^T)} \varepsilon^2. \quad (2.27)$$

Similarly, one can obtain the relative perturbation bound for the Lyapunov equation (2.21). Let Equation (2.21) be the perturbed equation related to $\tilde{A}_{22}\tilde{X}_{22} + \tilde{X}_{22}\tilde{A}_{22}^T = -I$, where $X_{22} = \tilde{X}_{22} + \Delta X_{22}$. Here $\alpha = \beta = \|\tilde{A}_{22}\|_F$ and $\gamma = \sqrt{n}$, thus from Equation (2.23) it follows

$$\|\Delta X_{22}\|_F \leq \sqrt{3}\|P_3^{-1}\|(2\|\tilde{A}_{22}\|_F\|\tilde{X}_{22}\|_F + \sqrt{n})\eta_2, \quad (2.28)$$

where $P_3 = I \otimes \tilde{A}_{22} + \tilde{A}_{22} \otimes I$ and $\eta_2 = \max \left\{ \frac{\|\Delta A_{22}\|_F}{\|\tilde{A}_{22}\|_F}, \frac{\|\varepsilon(E^T X_{12} + X_{12}^T E)\|_F}{\gamma} \right\}$. Since $\|E\|_F = 1$, using the triangle inequality we have

$$\eta_2 \leq \max \left\{ \frac{\|\Delta A_{22}\|_F}{\|\tilde{A}_{22}\|_F}, \varepsilon \frac{\|2X_{12}\|_F}{\sqrt{n}} \right\}. \quad (2.29)$$

From (2.25) it follows that $\|X_{12}\|_F$ is bounded by an $\mathcal{O}(\varepsilon)$ term, thus for small ε it yields

$$\max \left\{ \frac{\|\Delta A_{22}\|_F}{\|\tilde{A}_{22}\|_F}, \varepsilon \frac{\|2X_{12}\|_F}{\sqrt{n}} \right\} = \frac{\|\Delta A_{22}\|_F}{\|\tilde{A}_{22}\|_F}.$$

Now, (2.28) can be written in the form

$$\|\Delta X_{22}\|_F \leq \sqrt{3}\|P_3^{-1}\|(2\|\tilde{X}_{22}\|_F + \frac{\sqrt{n}}{\|\tilde{A}_{22}\|_F})\|\Delta A_{22}\|_F.$$

In order to express the previous bound in a relative form, divide the above equation by $\|\tilde{X}_{22}\|_F$ and express $\|P_3^{-1}\|$ in terms of sep, then we have

$$\frac{\|\Delta X_{22}\|_F}{\|\tilde{X}_{22}\|_F} \leq \frac{\sqrt{3}}{\text{sep}(\tilde{A}_{22}, -\tilde{A}_{22}^T)} \left(2 + \frac{\sqrt{n}}{\|\tilde{A}_{22}\|_F\|\tilde{X}_{22}\|_F} \right) \|\Delta A_{22}\|_F. \quad (2.30)$$

Note that $\|\tilde{X}_{22}\|_F$ and $\|\tilde{A}_{22}\|_F$ are easy to calculate since \tilde{X}_{22} and \tilde{A}_{22} are block diagonal matrices with 2×2 blocks on their diagonals which can be

expressed by analytic formulas.

To sum up, we obtain an error bound for the solution of the Lyapunov equation (2.14) computed by Algorithm 2.2.1. As we are interested in the trace, we only provide the bounds for the diagonal blocks of the solution.

Theorem 2.3.1. *With A_{11} , which is given in Algorithm 2.2.1, $\tilde{A}_{22} = \hat{A}_{\bar{p}(1)} \oplus \cdots \oplus \hat{A}_{\bar{p}(n-r)}$, $\Delta A_{22} = C(\bar{p}, \bar{p})$, and X_{ii} ($i = 1, 2$) being the exact solutions of equations (2.20), (2.21), \tilde{X}_{ii} their approximations computed by Algorithm 2.2.1, the error matrices $\Delta X_{ii} = X_{ii} - \tilde{X}_{ii}$ satisfy*

$$\frac{\|\Delta X_{11}\|_F}{\|X_{11}\|_F + \|X_{22}\|_F} \leq 6 \frac{1}{\text{sep}(A_{11}, -\tilde{A}_{22}^T)} \frac{1}{\text{sep}(A_{11}, -A_{11}^T)} \varepsilon^2, \quad (2.31)$$

$$\frac{\|\Delta X_{22}\|_F}{\|\tilde{X}_{22}\|_F} \leq \sqrt{3} \frac{\|\Delta A_{22}\|_F}{\text{sep}(\tilde{A}_{22}, -\tilde{A}_{22}^T)} \left(2 + \frac{\sqrt{n}}{\|\tilde{A}_{22}\|_F \|\tilde{X}_{22}\|_F} \right), \quad (2.32)$$

where $\varepsilon = \|C(p, \bar{p})\|_F$ and the vectors \bar{p} and p are calculated in Steps 1 and 2 of Algorithm 2.2.1, respectively.

In bound (2.32) we can use that $\|\tilde{X}_{22}\|_F = \frac{1}{2} \sqrt{(6 + \frac{8}{\alpha^2} + \alpha^2) \sum_{k=1}^{n-r} \omega_{\bar{p}(k)}^{-2}}$.

The right-hand sides in (2.31) and (2.32) thus also provide the desired, though conservative, bounds for the traces computed using the approximate Lyapunov solution rather than the exact ones. These bounds do not account for numerical errors made due to roundoff during the actual computations in finite-precision arithmetic, but if the analytical formula (2.7) is used for \hat{X}_i , X_{11} is computed by a numerically stable algorithm like the Bartels-Stewart method [5; 45] or Hammarling method [28], and ε is significantly larger than machine precision (which will usually be the case in applications), then the bounds (2.31) and (2.32) will dominate the numerical errors by far.

To make the bounds (2.31) and (2.32) operable we must estimate $\text{sep}(\cdot, \cdot)$. More about estimation of the separation can be found in [17; 22; 27; 46]. A survey of condition number estimation can be found in [31]. In [17], for the estimation of $\text{sep}(A, B)$, one must solve a Sylvester equation with coefficient matrices A and B . For solving this Sylvester or Lyapunov equation with

standard solvers (for example, the Bartels-Stewart algorithm [5]), the main costs are the calculation of Schur decompositions. In our case, we need Schur decompositions of matrices A_{11} and \tilde{A}_{22} . The Schur decompositions of \tilde{A}_{22} can be calculated easily since \tilde{A}_{22} is a block diagonal matrix which does not depend on external damping (thus in the optimization process this must be calculated only once). The Schur decompositions of the matrix A_{11} have already been obtained since in the calculation of the approximation of the solution we have already solved Lyapunov equations with matrices A_{11} . The availability of Schur decompositions cannot be utilized using the Lyapunov solvers in the MATLAB Control System ToolboxTM, but this is possible, for example in SLICOT (Subroutine Library In Control Theory¹) [44] and the SLICOT Basic Systems and Control Toolbox for MATLAB [7]. Employing the Schur decomposition usually accelerates the Lyapunov solver by a factor of 5 or more. Furthermore, in the estimation of the separation, the block diagonal structure of \tilde{A}_{22} can be used, too. Thus, separation estimation can be done efficiently.

In the following section we will propose an algorithm which uses these error bounds in the determination of optimal viscosity for given dampers' positions.

2.4 Calculation of the optimal viscosities

The algorithm for calculation of the optimal viscosities calculates the trace approximation using Algorithm 2.2.1. In the algorithm for viscosity optimization we check whether reduced dimension is good for a given accuracy. In order to check this efficiently we will use the new error bounds (2.31) and (2.32).

During the optimization process we do not check the error bounds, except when we determine suboptimal viscosity. Then we calculate the error bounds (2.31) and (2.32), and if the errors are small enough, we stop the optimization

¹See <http://www.slicot.org>.

process (then our suboptimal viscosity is close to optimal) or if errors are too large, we repeat the optimization process with a smaller tolerance, that is, with a larger reduced dimension r . All this is included in Algorithm 2.4.1. In Algorithm 2.4.1 parameter \mathbf{u} stands for machine precision.

Algorithm 2.4.1 (Computation of optimal viscosity at given damper positions)

Input: $\alpha, \kappa \geq 1$;

d_1, d_2, \dots, d_k – dampers' positions;

Φ – such that $\Phi^T K \Phi = \Omega^2 = \text{diag}(\omega_1^2, \dots, \omega_n^2)$ and $\Phi^T M \Phi = I$;

$\varepsilon_1, \varepsilon_2$ – the tolerances for the bounds (2.31) and (2.32), respectively;

tol_{start} – the starting tolerance for Algorithm 2.2.1;

c_1 – a constant for scaling a tolerance ($c_1 < 1$).

Output: Optimal viscosities $\hat{v}_1, \dots, \hat{v}_k$.

```

1:  $tol = tol_{start}$ 
2: while  $tol > \kappa \cdot u$  do
3:   Find suboptimal viscosities with an optimization algorithm, in the optimization process calculate the trace  $X(v_1, \dots, v_k)$  using Algorithm 2.2.1 with tolerance  $tol$ , and denote them with  $\hat{v}_1, \dots, \hat{v}_k$ .
4:   Calculate the right-hand sides of the bounds (2.31) and (2.32) for suboptimal viscosities  $\hat{v}_1, \dots, \hat{v}_k$ , and denote them by  $b_1$  and  $b_2$ , resp.
5:   if  $b_1 < \varepsilon_1$  and  $b_2 < \varepsilon_2$  then
6:     return optimal viscosities  $\hat{v}_1, \dots, \hat{v}_k$ 
7:   break
8:   else
9:      $tol = c_1 \cdot tol$ 
10:  end if
11: end while

```

Note that in Step 3, each time we start the optimization process for determining optimal viscosities. Moreover, in order to accelerate the optimization process our algorithm should use the information of suboptimal viscosities obtained in the previous step. For example, if we optimize with the Nelder-Mead method (as in the MATLAB function `fminsearch`, see for example [40]) in Step 3, then in the optimization process the starting values are the suboptimal viscosities obtained in the previous step, except for the first time when we take some fixed starting viscosities. Similarly, we can adopt our optimization process if we optimize with the Brent method (as in the MATLAB function

`fminbnd` see for example [15]). The application of the optimization method will be illustrated in the example in the next section.

2.5 Numerical experiments

In this section we will compare the application of the new algorithm for viscosity optimization using dimension reduction with the same optimization method without dimension reduction, based on the Bartels-Stewart Lyapunov solver. For that purpose we will consider the following example.

Example 2.1. Consider the mechanical system shown in Figure 2.2 with two dampers of the same viscosity and $3d + 1$ masses, consisting of three rows of masses with $d + 1$ springs. Each row has springs of the same stiffness equal to k_1, k_2, k_3 , respectively. On the left-hand side, rows of the springs are connected to the fixed base, and on the right-hand side they are connected to the last mass (m_{3d+1}), which is connected to the fixed base with the spring with stiffness k_4 .

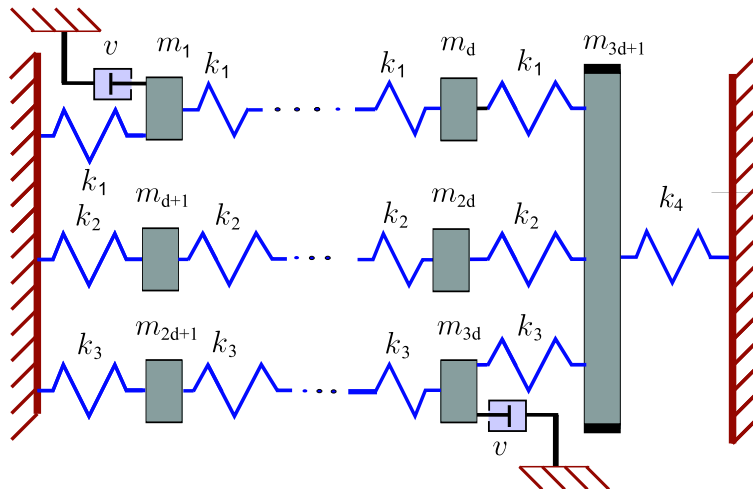

Figure 2.2: $3d + 1$ mass oscillator

The mathematical model for the considered vibrational system is given by equation $M\ddot{x} + D\dot{x} + Kx = 0$, where the mass matrix is

$$M = \text{diag}(m_1, m_2, \dots, m_n).$$

The stiffness matrix is defined as

$$K = \begin{bmatrix} K_{11} & & & -\kappa_1 \\ & K_{22} & & -\kappa_2 \\ & & K_{33} & -\kappa_3 \\ -\kappa_1^T & -\kappa_2^T & -\kappa_3^T & k_1 + k_2 + k_3 + k_4 \end{bmatrix},$$

where

$$K_{ii} = k_i \begin{bmatrix} 2 & -1 & & & \\ -1 & 2 & -1 & & \\ & \ddots & \ddots & \ddots & \\ & & -1 & 2 & -1 \\ & & & -1 & 2 \end{bmatrix}, \quad \kappa_i = \begin{bmatrix} 0 \\ \vdots \\ 0 \\ k_i \end{bmatrix}, \quad i = 1, 2, 3.$$

In this example we will consider the following configuration

$$\begin{aligned} d &= 500, & n &= 3d + 1 = 1501; \\ m_k &= k, & k &= 1, \dots, n; \\ k_1 &= 1, & k_2 &= 50, & k_3 &= 100, & k_4 &= 200. \end{aligned}$$

Our example has two dampers with the same viscosity v . Thus the damping matrix is equal to

$$D = C_u + C_{ext}, \quad \text{where } C_{ext} = ve_i e_i^T + ve_j e_j^T, \quad C_u = 0.005 \cdot C_{crit},$$

where C_{crit} is critical damping given in (1.3).

Since the considered optimization process is extremely demanding, instead of performing complete optimization (consisting of all dampers' positions) we

will relax the problem. We will compare our algorithm with the standard algorithm without dimension reduction on the equidistant mesh of dampers' positions:

$$i = 1 : 70 : n, \quad j = i + 5 : 70 : n,$$

where i is the position of the first damper and j is the position of the second damper, which results in 253 different positions.

In this example, we have two dampers of the same viscosity. Thus in Step 3 of Algorithm 2.4.1, for the optimization process, we will use the MATLAB function `fminbnd` with termination tolerances for the viscosity and for the function values equal to 10^{-4} .

Furthermore, in our application we have noticed that in Algorithm 2.4.1, if we set $\varepsilon_1 = \varepsilon_2 = 0.2$, then the relative errors for the approximation are good enough (relative errors are presented in Figure 2.3).

We have used the following configuration in Algorithm 2.4.1:

$$\begin{aligned} \alpha_c &= 0.005; & tol_{start} &= 3 \cdot 10^{-5}; \\ c_1 &= 0.2; & \kappa &= 10^4. \end{aligned}$$

The optimization process with `fminbnd` begins in the interval $[10^{-4}, 10^3]$. Once we have obtained the suboptimal viscosity \hat{v}_{opt} (in Step 3 of Algorithm 2.4.1), we check the error bounds in Step 5 of Algorithm 2.4.1. If the error bounds are small enough, the optimization process will be terminated (the suboptimal viscosity is then close enough to the optimal one). On the other hand, if the errors are not small enough, we continue with the process with the interval $[\hat{v}_{opt} - \hat{v}_{opt} \cdot p, \hat{v}_{opt} + \hat{v}_{opt} \cdot p]$, where we set $p = 0.01$.

Note that if `fminbnd` finds a suboptimal viscosity \hat{v}_{opt} at one of the interval boundaries, we will expand the interval around \hat{v}_{opt} , that is, we will restart the optimization process in the interval $[\hat{v}_{opt} - \hat{v}_{opt} \cdot p, \hat{v}_{opt} + \hat{v}_{opt} \cdot p]$.

In the following figures we have plotted data which corresponds to 100 smallest traces sorted by magnitude. The first result corresponds to the optimal position (the position which corresponds to the smallest trace).

Figure 2.3 shows relative errors for the optimal viscosity and the optimal trace. Relative errors for the trace are calculated using $|\text{trace } X - \text{trace } \hat{X}| / \text{trace } X$, where $\text{trace } X$ is the optimal trace for the given position obtained with the algorithm without dimension reduction, and $\text{trace } \hat{X}$ is the approximation of the optimal trace calculated with Algorithm 2.2.1. Similarly, relative errors for the optimal viscosity are calculated by $|\hat{v}_{opt} - v_{opt}| / v_{opt}$, where \hat{v}_{opt} is the optimal viscosity obtained by Algorithm 2.4.1 and v_{opt} is the exact optimal viscosity obtained by optimization without dimension reduction.

Both algorithms (with and without dimension reduction) obtain the same optimal damper position $(i, j) = (211, 426)$. According to the algorithm without dimension reduction, the optimal viscosity at this position is 32.75013 with the corresponding trace 2990313.07995, while with Algorithm 2.4.1 we obtain 32.74978 for the viscosity and 2990322.73886 for the trace.

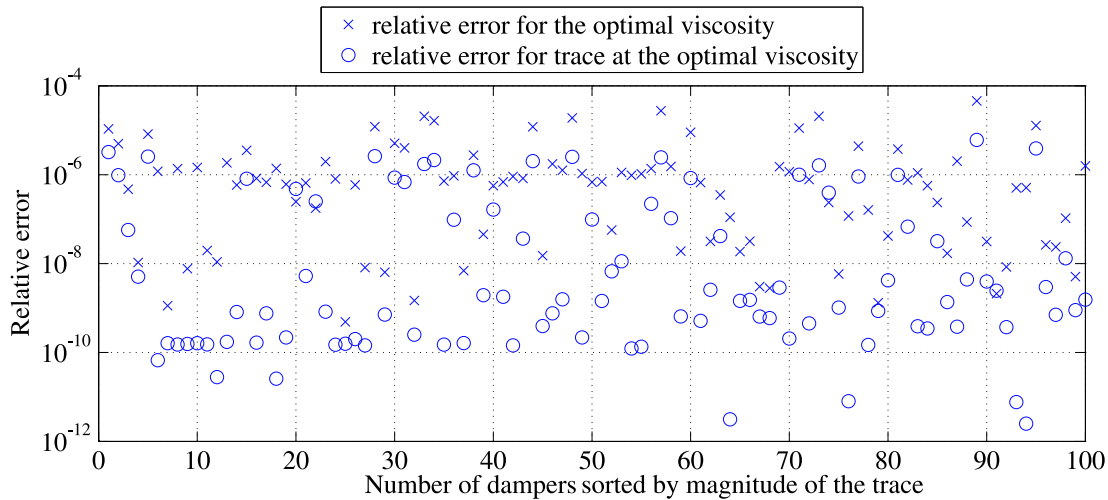

Figure 2.3: Relative errors

In the optimization process with the MATLAB function `fminbnd`, tolerances were equal to 10^{-4} , thus relative errors in Figure 2.3 are given in terms of tolerances for the optimization process. For all these results the while loop in Algorithm 2.4.1 just needed two iterations in order to satisfy inequalities in Step 5.

Reduced dimension r varies during the optimization process and Figure 2.4 shows the percentage of dimension reduction (calculated by $\frac{r}{n} \cdot 100$) at the optimal viscosity obtained when computing the 100 smallest traces. Each point in Figure 2.4 corresponds to such tolerance tol in Algorithm 2.4.1 that the inequalities in Step 5. of Algorithm 2.4.1 are satisfied.

We can see that the reduced dimension varies from 27% to 86% of the starting dimension. It is important to note that at the positions which have the smallest traces, the reduced dimension is the best. This is good because in calculating the optimal dampers' position with some heuristic we must calculate the optimal viscosity in a large number of dampers' positions which are close to the optimal damper position. Heuristics for determination of optimal damping (dampers' positions and corresponding viscosities) will be presented in Chapter 4.

In order to demonstrate how much the reduced dimension accelerates the optimization process, in Figure 2.5 we show the time ratio for calculating the optimal viscosity at given dampers' positions with Algorithm 2.4.1 and by the algorithm without dimension reduction. These times were calculated using an Intel(R) Core(TM) i7 CPU 920 with 12GB of RAM and 8 MB cache. From Figure 2.5 we can see that near the optimal trace, the new algorithm is about 15 times faster than the one without dimension reduction. If we are interested in the total time needed for calculating the optimal viscosities at the 100 smallest traces, then the algorithm without dimension reduction has needed 94.7 hours, while the algorithm with dimension reduction would needed 45.8 hours for the whole optimization process. Although for many positions the times are comparable or only a slight acceleration is observed, there are numerous instances where significant time savings are achieved, so that altogether, a

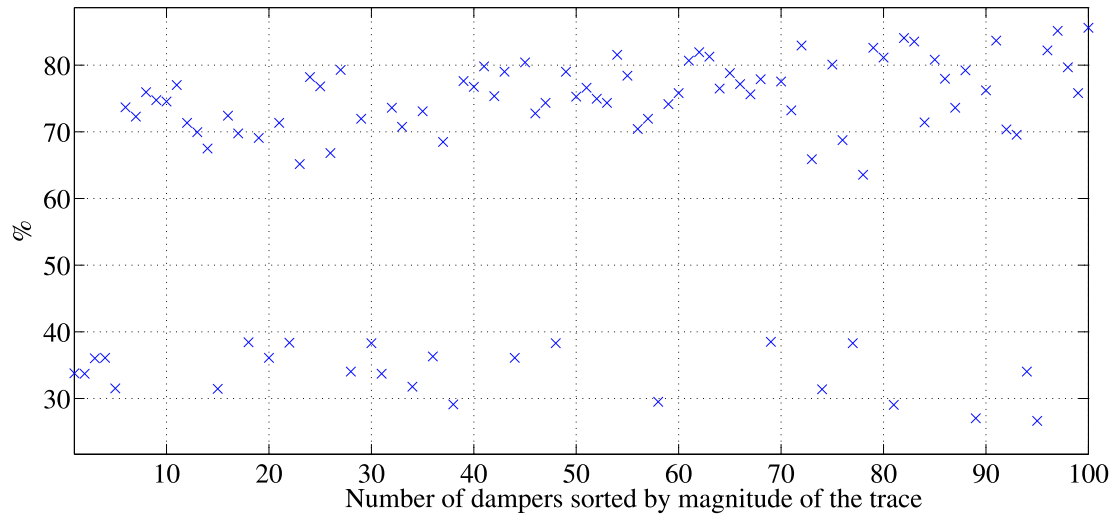

Figure 2.4: Reduced dimension

considerably shorter computation time for the whole optimization process is achieved.

Also, as we have mentioned above, at the positions which have the smallest traces the time ratio is better than in the other positions. Because of that, in calculating the optimal dampers' positions with some heuristic (for example some introduced in Chapter 4), we must calculate optimal viscosity in a large number of dampers' positions which are close to the optimal damper position and this will altogether accelerate the optimization process more.

In the next section we will consider the case of damping of selected eigenfrequencies, which will result in more significant acceleration of the optimization process.

2.6 Conclusions

Since the optimization process is extremely demanding, in this chapter we have suggested a dimension reduction technique that can significantly accelerate the

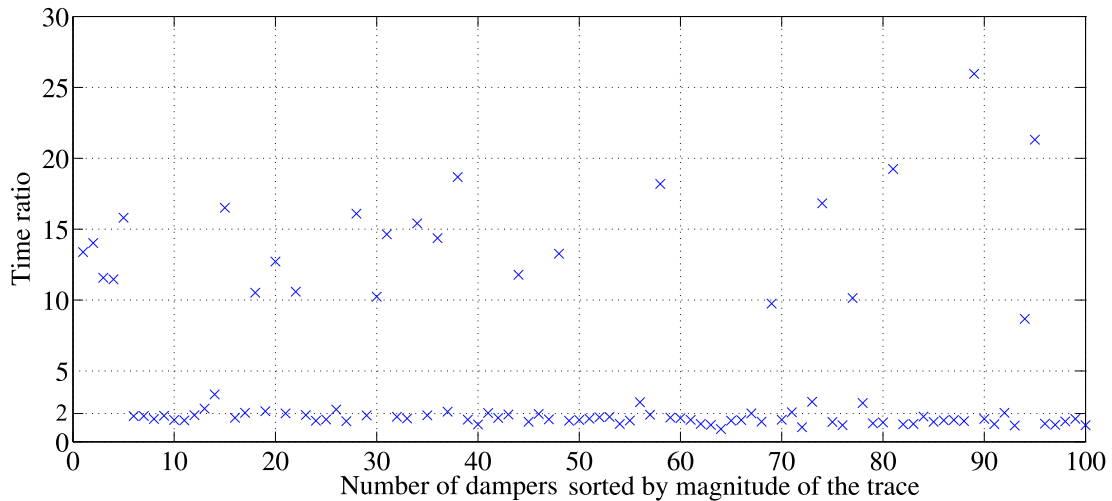

Figure 2.5: Time ratio

computation of traces. The idea is based on exploiting the structure of the coefficient matrices of the resulting Lyapunov equations and considering the terms introduced by damping as perturbations. Error bounds obtained from perturbation theory then guide us to those parts of the matrix that can be neglected so that parts of the trace calculation can then be obtained from analytical formulas and only a Lyapunov equation of much smaller size needs to be solved. Numerical experiments confirm the ability of this approximation technique to accelerate the optimization process significantly while ensuring that we still find the optima. In this chapter we have considered only the case when all undamped eigenfrequencies have to be damped and results which include damping of selected undamped eigenfrequencies will be presented in the following chapter.

Chapter 3

Optimal damping of selected eigenfrequencies using dimension reduction

In this chapter we will consider the case where selected undamped eigenfrequencies have to be damped. Matrix Z , that determines which part of eigenfrequencies has to be damped, is equal to $Z = GG^T$. Since we are interested in damping selected eigenfrequencies, that is, we are interested in damping of just the s ($s \ll n$) eigenfrequencies of the undamped system (s of them which correspond to the critical part), the matrix G has the following form

$$G = \begin{bmatrix} I_s & 0 \\ 0 & 0 \\ 0 & I_s \\ 0 & 0 \end{bmatrix}. \quad (3.1)$$

The corresponding Lyapunov equation is equal to

$$AX + XA^T = -GG^T, \quad A = \begin{bmatrix} 0 & \Omega \\ -\Omega & -\Phi^T D \Phi \end{bmatrix}. \quad (3.2)$$

Recall that matrix Φ is a matrix that simultaneously diagonalizes M and K , that is

$$\Phi^T K \Phi = \Omega^2 = \text{diag}(\omega_1^2, \dots, \omega_n^2) \quad \text{and} \quad \Phi^T M \Phi = I. \quad (3.3)$$

For the internal damping C_u it holds that $\Phi^T C_u \Phi = \alpha \Omega$ and $D = C_u + C_{ext}$, where C_{ext} describes external damping. With the above matrix G we will damp undamped eigenfrequencies $\omega_1, \omega_2, \dots, \omega_s$.

The main idea in this chapter is similar to the approach described in Chapter 2 where damping of the whole undamped spectrum was considered. The same approach as in Chapter 2 is possible, but this will not use all the benefit of the structure of the right-hand side of Equation (3.2). Particularly, if $s \ll n$, where $2s$ is the rank of G from (3.1), we can use the structure of the system more efficiently. Hence, the goal of this chapter is to derive a new error bound for the trace of the solution of the Lyapunov equation (3.2) and to construct a corresponding efficient numerical algorithm for the trace approximation.

Using the structure of our system

$$M\ddot{x} + D\dot{x} + Kx = 0, \quad (3.4)$$

first we will derive an approximation of the trace of the solution of the Lyapunov equation (3.2) and a corresponding error bound for the approximation. Our algorithm for approximation of optimal damping will employ this approximation in order to efficiently determine optimal viscosities. Also, for structured systems using this approach we can efficiently determine the area where optimal dampers' positions are located, which will be presented in Section 4.5. Numerical results illustrate the efficiency of our approaches.

Similarly to the Chapter 2, here we construct one truncation matrices Q such that system (3.4) can be approximated with following system of smaller dimension

$$M_r \ddot{y} + D_r \dot{y} + K_r y = 0, \quad (3.5)$$

where $x = Qy$ and

$$\begin{aligned} M_r &= Q^T M Q, \\ D_r &= Q^T D Q, \\ K_r &= Q^T K Q. \end{aligned}$$

Matrix Q is an $n \times r$ matrix with full column rank. From the above reduced system we can derive a corresponding Lyapunov equation (of smaller dimension $2r \times 2r$ ($r < n$)) from which we can obtain an approximation for the trace of the solution of the Lyapunov equation.

3.1 Approximating the trace of the solution of the Lyapunov equation

In this section we will present an algorithm which calculates an approximation of the trace of the solution of the structured Lyapunov equation (3.2). For that purpose, similarly to Section 2.1, we apply the perfect shuffle permutation matrix P , which yields the Lyapunov equation

$$A_P X_P + X_P A_P^T = -P^T G G^T P, \quad (3.6)$$

with $A_P = P^T A P$ and $X_P = P^T X P$, where A is given in Equation (3.2) and G is given in Equation (3.1).

Our approach is based on dimension reduction of the Lyapunov equation (3.6). That is, we will construct an approximation of the Lyapunov equation (3.6) as follows:

$$\tilde{A}_P \tilde{X}_P + \tilde{X}_P \tilde{A}_P^T = -G_P G_P^T,$$

where $\hat{G} = P^T G$ and A_P is approximated by

$$\tilde{A}_P = \begin{bmatrix} \tilde{A}_{11} & 0 \\ 0 & \tilde{A}_{22} \end{bmatrix}.$$

Now we will describe the construction of \tilde{A}_{11} , \tilde{A}_{22} in more details. For this, we will need the additional permutation matrix \hat{P} which will bring up the dominant part of the damping matrix D to the upper block diagonal part.

Recall that the given damper positions and corresponding viscosities are included in the matrix $C = \Phi^T C_{ext} \Phi$, where Φ is given in (3.3).

Let the vectors $p \in \mathbb{N}^r$ and $\bar{p} \in \mathbb{N}^{n-r}$ be chosen such that the following conditions hold:

- i) $p \cup \bar{p} = \{1, 2, \dots, n\}$;
- ii) p is the vector of indices of dimension $s + \hat{s}$, where the first s correspond to the eigenfrequencies which have to be damped, and the \hat{s} closest indices;
- iii) \bar{p} and p are the vectors of indices such that $\max_{ij} |C(\bar{p}(i), p(j))| \leq tol$, for a given tolerance tol .

The vectors $p \in \mathbb{N}^r$ and $\bar{p} \in \mathbb{N}^{n-r}$ should be chosen such that r is as small as possible for given parameters s , \hat{s} and tol . A strategy for determining $p \in \mathbb{N}^r$ and $\bar{p} \in \mathbb{N}^{n-r}$ will be discussed below.

The vector $w \in \mathbb{N}^n$ is defined by $w(i) = p(i)$ for $i = 1, \dots, r$ and $w(i) = \bar{p}(i-r)$ for $i = r+1, \dots, n$.

Now, instead of the Lyapunov equation (3.2), we solve the permuted Lyapunov equation

$$\hat{P}^T P^T A P \hat{P} \hat{X}_P + \hat{X}_P \hat{P}^T P^T A^T P \hat{P} = -\hat{G} \hat{G}^T, \quad (3.7)$$

where $\hat{X}_P = \hat{P}^T X_P \hat{P}$, $\hat{G} = \hat{P}^T P^T G$, the matrix P is the perfect shuffle permutation matrix and $\hat{P} = I(:, w) \otimes I_2$. Note that for these permutations

it holds

$$\widehat{A}_P = \begin{bmatrix} 0 & \omega_{w(1)} & \cdots & 0 & 0 \\ -\omega_{w(1)} & -\alpha\omega_{w(1)} - c_{w(1)w(1)} & \cdots & 0 & -c_{w(1)w(n)} \\ \vdots & \vdots & \ddots & \vdots & \vdots \\ 0 & 0 & \cdots & 0 & \omega_{w(n)} \\ 0 & -c_{w(1)w(n)} & \cdots & -\omega_{w(n)} & -\alpha\omega_{w(n)} - c_{w(n)w(n)} \end{bmatrix},$$

where

$$\widehat{A}_P = \widehat{P}^T P^T A P \widehat{P}. \quad (3.8)$$

Since \widehat{P} and P are permutation matrices, it holds that $\text{trace } \widehat{X}_P = \text{trace } X$, where X is the solution of Equation (3.2).

We are interested in dimension reduction which will allow us to solve the approximated Lyapunov equation of smaller dimension instead of solving the Lyapunov equation (3.7). The approximated Lyapunov equation will have the following form:

$$\widetilde{A}_P \widetilde{X}_P + \widetilde{X}_P \widetilde{A}_P^T = -\widetilde{G} \widehat{G}^T, \quad (3.9)$$

where

$$\widetilde{A}_P = \begin{bmatrix} \widetilde{A}_{11} & 0 \\ 0 & \widetilde{A}_{22} \end{bmatrix},$$

and

$$\widetilde{A}_{11} = \widehat{A}_P(1 : 2r, 1 : 2r) \quad \text{and} \quad \widetilde{A}_{22} = \widehat{A}_P(2r + 1 : 2n, 2r + 1 : 2n),$$

where \widehat{A}_P is given in Equation (3.8). Because of the block structure of \widetilde{A}_P and $\widehat{G} = \begin{bmatrix} I_{2s} & 0 \end{bmatrix}^T$, the approximation of the solution of the Lyapunov equation (3.7) is given by

$$\widetilde{X}_P = \begin{bmatrix} \widetilde{X}_{11} & 0 \\ 0 & 0 \end{bmatrix},$$

where \widetilde{X}_{11} is the solution of the Lyapunov equation

$$\widetilde{A}_{11} \widetilde{X}_{11} + \widetilde{X}_{11} \widetilde{A}_{11}^T = -\widetilde{G} \widetilde{G}^T \quad (3.10)$$

with $\tilde{G} = \hat{G}(1 : 2r, :)$.

Since \tilde{X}_P is the approximation of the solution X of the Lyapunov equation (3.7) we can use it for the trace approximation. This approximation will be obtained by solving a Lyapunov equation of dimension $2r \times 2r$, thus we will call the parameter r the reduced dimension.

Note that the reduced dimension will be smaller if the matrix C has more elements small by magnitude. The matrix C is obtained from the corresponding rows of the matrix Φ from (3.3), which is explained in Section 2.1.1. Thus, the structure of the matrix Φ is related to the magnitude of the elements of the matrix C .

Now we will present Algorithm 3.1.1 for the construction of vectors p and \bar{p} .

Algorithm 3.1.1 (construction of p and \bar{p})

Input: *tol*;

$v_i, C_i, i = 1, \dots, k$, - (C_i describes the geometry of the i th damper position with viscosity v_i);

u_1, u_2, \dots, u_s , - s indices of those eigenfrequencies which have to be damped;

$\hat{u}_1, \hat{u}_2, \dots, \hat{u}_{\hat{s}}$, - \hat{s} indices of the eigenfrequencies closest to the eigenfrequencies which have to be damped.

Output: p, \bar{p}

- 1: $p = [u_1, u_2, \dots, u_s, \hat{u}_1, \hat{u}_2, \dots, \hat{u}_{\hat{s}}]$
 - 2: Determine vector \bar{p} such that $p \cup \bar{p} = \{1, 2, \dots, n\}$.
 - 3: $T=1$
 - 4: $C = \Phi^T(v_1 C_1 + v_2 C_2 + \dots + v_k C_k)\Phi$
 - 5: **while** $T=1$ **do**
 - 6: $\hat{C} = C(p, \bar{p})$ and $M = \max_{ij} |\hat{C}_{i,j}|$.
 - 7: **if** $M > tol$ **then**
 - 8: Determine indices i_0, j_0 such that $M = |C_{i_0, j_0}|$ (ensuring that j_0 is not used before and i_0 is index which is element of p).
 - 9: $p = [p, j_0]$.
 - 10: Determine the vector \bar{p} such that $p \cup \bar{p} = \{1, 2, \dots, n\}$.
 - 11: **else**
 - 12: $T = 0$
 - 13: **end if**
 - 14: **end while**
-

We like to emphasize that in Algorithm 3.1.1, the indices $\hat{u}_1, \hat{u}_2, \dots, \hat{u}_{\hat{s}}$ are included in vector p in order to obtain a better approximation of the eigenfrequencies which are closest to the eigenfrequencies to be damped. Furthermore, numerical experiments suggest that \hat{s} should be around 1 – 4% of the dimension n .

Besides the indices determining the eigenfrequencies to be damped and their closest neighbors, the algorithm chooses the indices to be included in the approximation (3.9) of the Lyapunov equation (3.6) by ensuring that all elements of the matrix C to be omitted are smaller than the chosen tolerance tol . Note that we use the term $\max_{i,j} |C(p(i), \bar{p}(j))| < tol$ since our error bound will be given in the absolute terms. On the other hand, one can use the relative terms, such as $|C(p(i), \bar{p}(j))| < tol \|C\|_{\infty}$, then error bound should be also in the relative terms.

Once we obtain the vectors p and \bar{p} we can introduce Algorithm 3.1.2 for calculating the trace approximation.

Remark 3.1.1. *Approximation of the trace of the Lyapunov equation calculated with Algorithm 3.1.2 corresponds to the trace of the solution of the Lyapunov equation which is obtained from the reduced system (3.5) using the truncation matrix $Q = \Phi(:, p)$ where Φ is defined in (3.3) and p is calculated with Algorithm 3.1.1.*

Remark 3.1.2. *Note that in our approximation algorithm we have assumed that internal damping is defined as in (1.3-1.4) but this algorithm can be easily extended to the proportional damping defined in (1.5) or to general case where system is modally damped (C_u is diagonalized by matrix Φ). This is also the case for the dimension reduction described in Chapter 2.*

The question is: *how accurate is* Algorithm 3.1.2? The following section provides an error bound for the approximation given by Algorithm 3.1.2.

Algorithm 3.1.2 (Approximation of the trace of the solution of the Lyapunov equation (3.2))

Input: α, Φ – such that $\Phi^T K \Phi = \Omega^2 = \text{diag}(\omega_1^2, \dots, \omega_n^2)$ and $\Phi^T M \Phi = I$;
 $v_i, C_i, i = 1, \dots, k$, – (C_i describes the geometry of the i th damper position with viscosity v_i);
 $p(1), p(2), \dots, p(s)$ – indices of the eigenfrequencies which have to be damped;
 \hat{s} – number of additional indices which are needed for Algorithm 3.1.1;
 tol – tolerance needed for Algorithm 3.1.1.

Output: trace $X(C)$

- 1: Determine vectors $\bar{p} \in \mathbb{N}^{n-r}$ and $p \in \mathbb{N}^r$ using Algorithm 3.1.1.
- 2: $\Omega_r = \text{diag}(\omega_{p(1)}, \omega_{p(2)}, \dots, \omega_{p(r)})$
- 3: $C = \Phi^T (v_1 C_1 + v_2 C_2 + \dots + v_k C_k) \Phi$
- 4: Calculate X_{11} , where

$$A_{11} X_{11} + X_{11} A_{11}^T = -\tilde{G} \tilde{G}^T, \quad A_{11} = P^T \begin{bmatrix} 0 & \Omega_r \\ -\Omega_r & -\alpha \Omega_r - C(p, p) \end{bmatrix} P,$$

$$\tilde{G} = [I_{2s} \ 0]^T, \quad P \text{ is the perfect shuffle permutation matrix.}$$

- 5: trace $X(C) \approx \text{trace } X_{11}$.
-

3.2 Error bound

Consider the partitioned form of permuted Lyapunov equation (3.7):

$$\begin{bmatrix} A_{11} & A_{12} \\ A_{12}^T & A_{22} \end{bmatrix} \begin{bmatrix} X_{11} & X_{12} \\ X_{12}^T & X_{22} \end{bmatrix} + \begin{bmatrix} X_{11} & X_{12} \\ X_{12}^T & X_{22} \end{bmatrix} \begin{bmatrix} A_{11}^T & A_{12} \\ A_{12}^T & A_{22}^T \end{bmatrix} = -\hat{G} \hat{G}^T, \quad (3.11)$$

where

$$A = \begin{bmatrix} A_{11} & A_{12} \\ A_{12}^T & A_{22} \end{bmatrix}, \quad X = \begin{bmatrix} X_{11} & X_{12} \\ X_{12}^T & X_{22} \end{bmatrix}. \quad (3.12)$$

The matrix \hat{G} has rank $2s$ and has the form $\hat{G} = [I_{2s} \ 0]^T$, where $s \leq r$ (r is the reduced dimension and according to our approximation algorithm $\dim(A_{11}) = 2r \geq 2s$).

Equation (3.11) can be considered as the perturbed equation of

$$\begin{bmatrix} A_{11} & 0 \\ 0 & A_{22} \end{bmatrix} \begin{bmatrix} \tilde{X}_{11} & \tilde{X}_{12} \\ \tilde{X}_{12}^T & \tilde{X}_{22} \end{bmatrix} + \begin{bmatrix} \tilde{X}_{11} & \tilde{X}_{12} \\ \tilde{X}_{12}^T & \tilde{X}_{22} \end{bmatrix} \begin{bmatrix} A_{11}^T & 0 \\ 0 & A_{22}^T \end{bmatrix} = -\hat{G}\hat{G}^T. \quad (3.13)$$

For the sequel, we define

$$\tilde{A} = \begin{bmatrix} A_{11} & 0 \\ 0 & A_{22} \end{bmatrix}, \quad \tilde{X} = \begin{bmatrix} \tilde{X}_{11} & \tilde{X}_{12} \\ \tilde{X}_{12}^T & \tilde{X}_{22} \end{bmatrix}. \quad (3.14)$$

Note that $\tilde{X}_{12} = 0$, $\tilde{X}_{22} = 0$ and \tilde{X}_{11} is the solution of the equation

$$A_{11}\tilde{X}_{11} + \tilde{X}_{11}A_{11}^T = -\tilde{G}\tilde{G}^T, \quad (3.15)$$

where $\tilde{G} = \hat{G}(1 : 2r, 1 : 2s)$. Observe that in Algorithm 3.1.2 we solve Equation (3.13) instead of (3.11), thus we are interested in the error bound for

$$\frac{|\text{trace}(X) - \text{trace}(\tilde{X}_{11})|}{\text{trace}(X)}, \quad (3.16)$$

where X is the solution of (3.11) and \tilde{X}_{11} is the solution of (3.15).

Our error bound will be based on the results from [18], where the authors considered the Sylvester equation

$$AX - XB = C, \quad (3.17)$$

perturbed such that

$$(A + \Delta A)(X + \Delta X) - (X + \Delta X)(B + \Delta B) = C + \Delta C.$$

As one can find in [18], the first order approximation for a change in a scalar function g with respect to perturbations is given by

$$|g(X(0)) - g(X(\eta))| \approx \sum_{\eta} \left| \frac{dg}{d\eta} \right| |\eta|. \quad (3.18)$$

First we need to say that we consider \tilde{X} as a perturbation of $X =: X(0)$ with respect to a parameter η and that we are merely interested in the scalar function $\text{trace}(X)$ rather than X itself.

The approximation (3.18) corresponds to a first order approximation using Taylor expansion and the perturbation η determines the absolute change of the corresponding elements of the solution $X(0)$. When the perturbation η is small ($|\eta| \leq \varepsilon, \forall \eta$) we have

$$|g(X(0)) - g(X(\eta))| \lesssim \varepsilon \sum_{\eta} \left| \frac{dg}{d\eta} \right|. \quad (3.19)$$

Let $a_{ij} = (A)_{ij}$, $b_{ij} = (B)_{ij}$, $c_{ij} = (C)_{ij}$ be the entries of A , B , C , respectively. A bound for $\sum_{\eta} \left| \frac{dg}{d\eta} \right|$ from (3.19), which is independent of the perturbation η , is given in [18, (33)] with

$$\begin{aligned} \sum_{\eta} \left| \frac{dg}{d\eta} \right| &\leq \text{trace}(|\Lambda|^T |C|) + \sum_{i,j} \left| \sum_k a_{ji} \lambda_{ik} x_{jk} \right| + \sum_{i,j} \left| \sum_k b_{ij} \lambda_{kj} x_{ki} \right| \\ &= \text{trace}(|\Lambda|^T |C|) + \sum_{i,j} |a_{ji}| |(\Lambda X)_{ij}| + \sum_{i,j} |b_{ij}| |(\Lambda X)_{ji}|, \end{aligned} \quad (3.20)$$

where Λ is the solution of the Sylvester equation

$$A^T \Lambda - \Lambda B^T = \frac{dg}{dX}.$$

For the error bound (3.16), the scalar function g from (3.19) is $g(X) = \text{trace } X$. Using that $\frac{d \text{trace}(AX)}{dX} = A^T$ (see for example [23]) it yields that

$$\frac{dg}{dX} = \frac{d \text{trace}(X)}{dX} = I.$$

Hence, in our case we have to calculate Λ from the equation

$$\tilde{A}^T \Lambda + \Lambda \tilde{A} = I.$$

As one can see from Equation (3.14), matrix \tilde{A} has block diagonal form, which means that Λ is block diagonal matrix of the form

$$\Lambda = \begin{bmatrix} \Lambda_{11} & 0 \\ 0 & \Lambda_{22} \end{bmatrix}, \quad (3.21)$$

where the diagonal blocks of Λ are the solutions of the following Lyapunov equations

$$A_{11}^T \Lambda_{11} + \Lambda_{11} A_{11} = I, \quad (3.22)$$

$$A_{22}^T \Lambda_{22} + \Lambda_{22} A_{22} = I.$$

Further we will show that we can bound (3.16) using only Λ_{11} .

From (3.19) and (3.20) with $g(X) = \text{trace}(X)$ it follows that

$$\begin{aligned} |\text{trace}(X) - \text{trace}(\tilde{X}_{11})| &\lesssim \\ &\lesssim \varepsilon \left(\text{trace}(|\Lambda|^T |\hat{G}\hat{G}^T|) + \sum_{i,j} |\tilde{a}_{ji}| |(\Lambda\tilde{X})_{ij}| + \sum_{i,j} |\tilde{a}_{ji}| |(\Lambda\tilde{X})_{ji}| \right), \end{aligned} \quad (3.23)$$

where ε satisfies $|(A_{12})_{ij}| \leq \varepsilon, \forall i, j$, $(\tilde{A})_{ij} = \tilde{a}_{ij}$ and \tilde{X} are given in (3.14).

Note that the vector p from Algorithms 3.1.1 and 3.1.2 determines the permutations such that the elements of A_{12} are small by absolute value (they are smaller than tolerance tol), which means that ε will be small, too.

Now, we can state the following theorem.

Theorem 3.2.1. *Let vectors p, \bar{p} be determined by Algorithm 3.1.1. Let X be the exact solution of (3.11) with approximation X_{11} computed by Algorithm 3.1.2, and let Λ_{11} be the solution of (3.22). For $\varepsilon = \max_{i,j} |C(p, \bar{p})|$, if ε is small enough it holds*

$$\begin{aligned} \frac{|\text{trace}(X) - \text{trace}(\tilde{X}_{11})|}{\text{trace}(\tilde{X}_{11})} &\lesssim \frac{\varepsilon}{\text{trace}(\tilde{X}_{11})} \left(\text{trace}(|\Lambda_{11}|^T |\tilde{G}\tilde{G}^T|) \right. \\ &\quad \left. + \sum_{i,j=1}^{2r} |\tilde{a}_{ji}| |(\Lambda_{11}\tilde{X}_{11})_{ij}| + \sum_{i,j=1}^{2r} |\tilde{a}_{ji}| |(\Lambda_{11}\tilde{X}_{11})_{ji}| \right), \end{aligned} \quad (3.24)$$

where $(A_{11})_{ij} = \tilde{a}_{ij}$ and A_{11} is determined by Algorithm 3.1.2.

Proof. The local first-order bound (3.24) is obtained directly from the local first-order bound (3.23), using the block structure of Λ defined in (3.21) and \tilde{X} defined in (3.14). □

Note that ε from the right-hand side of the above error bound, in the terms of Algorithms 3.1.1 and 3.1.2, is equal to $\varepsilon = \max_{i,j} |C(p(i), \bar{p}(j))|$. Also, this error bound now includes the structure of the right-hand side (Λ_{11} is multiplied with the right hand side of the Lyapunov equation), and the structure of \tilde{A} .

Since

$$\frac{|\text{trace}(X) - \text{trace}(\tilde{X}_{11})|}{\text{trace}(X)} \approx \frac{|\text{trace}(X) - \text{trace}(\tilde{X}_{11})|}{\text{trace}(\tilde{X}_{11})},$$

we will use the bound (3.24) as an estimate for the relative error given in (3.16).

For calculating the upper error bound (3.24), we need to solve the Lyapunov equations (3.15) and (3.22) which have dimension $2r \times 2r$ (the same matrix A_{11} determines the Lyapunov equation), which makes this bound easy to calculate.

3.3 An algorithm for the approximation of optimal viscosities

We will present an algorithm which calculates an approximation of the optimal viscosities using Algorithm 3.1.2 and the error bound (3.24).

In the optimization process we do not check the error bound for each approximation. When we determine a suboptimal viscosity we calculate the error bound (3.24) and if the error is small enough we stop the optimization process (then our suboptimal viscosities are expected to be close to the optimal ones). On the other hand, if the error is too large we repeat the optimization

process with a smaller tolerance, that is, we increase the reduced dimension r .

In Algorithm 3.3.1 we present an algorithm for calculation of the optimal viscosity at given dampers' positions. Each time we start a new optimization process for determination of the optimal viscosities in Step 4 of Algorithm 3.3.1, thus in order to accelerate the optimization process, our algorithm should use the information of suboptimal viscosities obtained in the previous step. This means that if we optimize with the Nelder-Mead method in Step 4 of Algorithm 3.3.1, first time we take some fixed starting viscosities $v_1^0, v_2^0, \dots, v_k^0$, then in every other step of the optimization process the starting values are the suboptimal viscosities obtained from the previous step. In Algorithm 3.3.1, the parameter \mathbf{u} denotes the machine precision.

Remark 3.3.1. *Note that the reduced dimension r changes during the viscosity optimization. Because of that, in optimizing with Nelder-Mead algorithm, we have noticed some technical details which can improve numerical performance of our method. In order to improve convergence of our optimization algorithm we do not need to recalculate vectors p and \bar{p} each time (in Step 1 of Algorithm 3.1.2), that is, in procedure of viscosity optimization by Nelder-Mead algorithm if viscosities are changed for just small percentage (e.g. smaller than 10%) we can use the same vectors p and \bar{p} . Furthermore, when the reduced dimension is changed during the optimization process, it is good to ensure that all points in corresponding simplex, correspond to the same reduced dimension.*

3.4 Numerical experiments

In this section we will present examples which compare the new algorithm for viscosity optimization using dimension reduction with the same optimization method without dimension reduction. In these examples Lyapunov equations have been solved by the Bartels-Stewart Lyapunov solver implemented in MATLAB function `lyap`.

Algorithm 3.3.1 (Computing optimal viscosities at given dampers' positions)

Input: $\alpha, \kappa \geq 1$;

Φ – such that $\Phi^T K \Phi = \Omega^2 = \text{diag}(\omega_1^2, \dots, \omega_n^2)$ and $\Phi^T M \Phi = I$;

$p(1), p(2), \dots, p(s)$ – indices of eigenfrequencies which have to be damped;

\hat{s} – number of additional indices which are needed for Algorithm 3.1.1;

ε – the tolerance for the relative error bound (3.24);

tol_{start} – the starting tolerance for viscosity optimization;

c_1 – a positive constant for scaling a tolerance ($c_1 < 1$);

$v_1^0, v_2^0, \dots, v_k^0$ – starting viscosities for the optimization process;

d_1, d_2, \dots, d_k – dampers' position at which viscosity should be optimized.

Output: Optimal viscosities $\hat{v}_1, \dots, \hat{v}_k$

- 1: $tol = tol_{start}$
 - 2: $\hat{v}_1 = v_1^0, \hat{v}_2 = v_2^0, \dots, \hat{v}_k = v_k^0$
 - 3: **while** $tol > \kappa \cdot \mathbf{u}$ **do**
 - 4: Calculate new suboptimal viscosities using an optimization algorithm (e.g. Nelder-Mead), based on Algorithm 3.1.2 for calculation of the trace $X(v_1, \dots, v_k)$ with starting points $\hat{v}_1, \hat{v}_2, \dots, \hat{v}_k$ and tolerance tol .
 - 5: Calculate the right-hand side of the bounds (3.24) at suboptimal viscosities $\hat{v}_1, \dots, \hat{v}_k$, and denote it by η .
 - 6: **if** $\eta < \varepsilon$ **then**
 - 7: **return** optimal viscosities are $\hat{v}_1, \dots, \hat{v}_k$
 - 8: **break**
 - 9: **else**
 - 10: $tol = c_1 \cdot tol$
 - 11: **end if**
 - 12: **end while**
-

Example 3.1. We will consider an n -mass oscillator or oscillator ladder with two dampers, shown in Figure 3.1, which describes the mechanical system of n masses and $n + 1$ springs with stiffness being equal to k . Recall that, for such a mechanical system the mathematical model is given by $M\ddot{x} + D\dot{x} + Kx = 0$

where for the mass and stiffness matrices we have that

$$M = \text{diag}(m_1, m_2, \dots, m_n),$$

$$K = k \cdot \begin{pmatrix} 2 & -1 & & & \\ -1 & 2 & -1 & & \\ & \ddots & \ddots & \ddots & \\ & & -1 & 2 & -1 \\ & & & -1 & 2 \end{pmatrix}.$$

The damping matrix is

$$D = C_u + C_{ext}, \quad \text{where the internal damping } C_u \text{ is defined as in (1.3).}$$

Since we will consider two dampers of different viscosity, the external damping is defined by $C_{ext} = v_1 e_i e_i^T + v_2 e_j e_j^T$, where $1 \leq i < j \leq n$.

We will consider the following configuration

$$\begin{aligned} n &= 1600; \\ m_i &= 120 - (i - 1)/5, \quad i = 1, \dots, 100; \\ m_i &= i, \quad i = 101, \dots, n; \\ k &= 4. \end{aligned} \tag{3.25}$$

We would like to damp all the eigenfrequencies of the undamped system, which are smaller than 0.005 by magnitude. Thus, for the above configuration, we

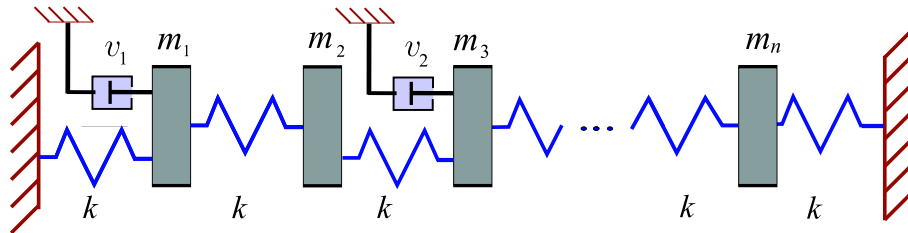

Figure 3.1: n -mass oscillator with two dampers

obtain $s = 34$ (s determines the matrix G from (3.1)).

Recall that considered optimization process is extremely demanding, because it requires solving the Lyapunov equation (3.2) numerous times (for more details see Chapter 4). Thus, instead of performing optimization over all dampers' positions (which is described by Algorithm 4.1.1), we will compare the new algorithm with the standard algorithm (optimization without dimension reduction) on the equidistant mesh of dampers' positions

$$i = 51 : 50 : n, \quad j = i + 51 : 50 : n \quad (3.26)$$

which will give 465 different dampers' positions. Furthermore, for the purpose of better illustration of obtained results, we will restrict our comparison on the data which corresponds to the 99 smallest traces (sorted by magnitude).

We have used the following configuration in Algorithm 3.3.1 (the undamped eigenfrequencies are sorted such that $\omega_1 < \omega_2 < \dots < \omega_n$):

$$\begin{aligned} \alpha_c &= 0.001; & \kappa &= 10^4; \\ p(i) &= i, \quad i = 1, \dots, s; & \hat{s} &= 60; \\ \varepsilon &= 0.1; & tol_{start} &= 0.002; \\ c_1 &= 0.5; & v_1^0 &= v_2^0 = 50. \end{aligned}$$

For the viscosity optimization we have used the Nelder-Mead algorithm [40] implemented in MATLAB function `fminsearch`. The termination tolerance for the function value is 0.1 and the termination tolerance for the optimization variable is set to 0.001. Note that these tolerances are absolute, thus they are appropriate for our optimization since the function values is around 10^6 and optimal viscosities vary from 10 to 1000.

With both algorithms (with and without dimension reduction) we obtain the same optimal positions (with respect to the mesh given by configuration (3.26)) and these are the positions $(i, j) = (651, 1352)$ with the optimal viscosities $(v_1, v_2) = (107.03009, 150.49333)$ while the optimal trace is

$$\text{trace}(X(v_1, v_2)) = 993\,067.32851.$$

Figures 3.2-3.4 present comparisons between results obtained with the new algorithm with dimension reduction and with the standard approach (algorithm without dimension reduction). As we have mentioned above, we have plotted the data which corresponds to the 99 smallest traces sorted by magnitude. The first data point corresponds to the optimal position which is given above, that is the position which corresponds to the smallest trace.

Figure 3.2 shows the relative errors for the optimal trace at the given dampers' positions. The relative errors for the trace are calculated using $|\text{trace } X - \text{trace } \tilde{X}_{11}| / \text{trace } X$, where $\text{trace } X$ is the optimal trace for the given position obtained with the algorithm without dimension reduction, and $\text{trace } \tilde{X}_{11}$ is the approximation of the optimal trace calculated by Algorithm 3.3.1.

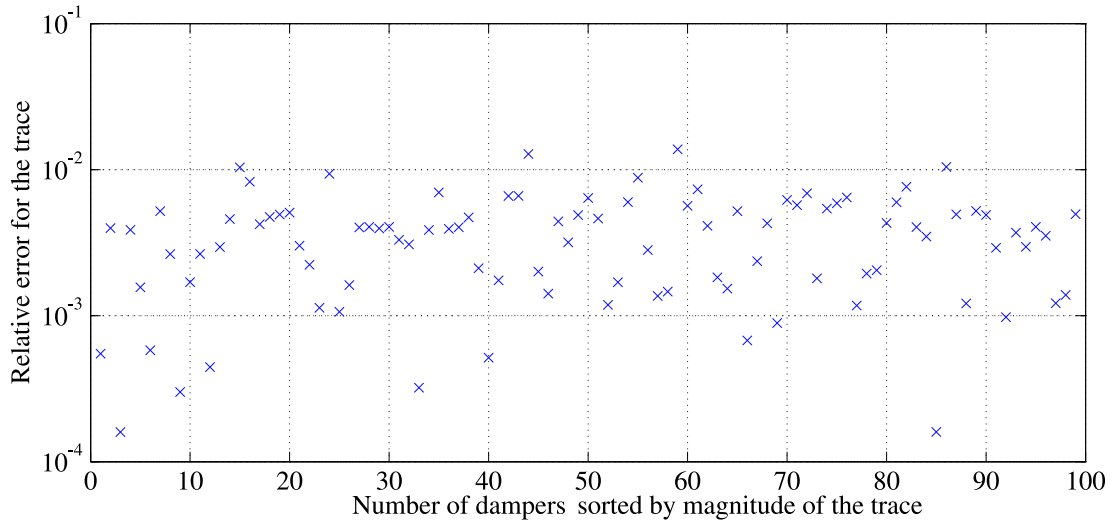

Figure 3.2: Relative error for the trace

Figure 3.3 shows the relative errors for the optimal viscosities (first and second viscosity). The relative error for i th viscosity ($i = 1, 2$) is calculated as $|\tilde{v}_i^{opt} - v_i^{opt}| / v_i^{opt}$, where \tilde{v}_i^{opt} is the i th optimal viscosity obtained by Algorithm 3.3.1 and v_i^{opt} is the i th exact optimal viscosity obtained by optimization without dimension reduction.

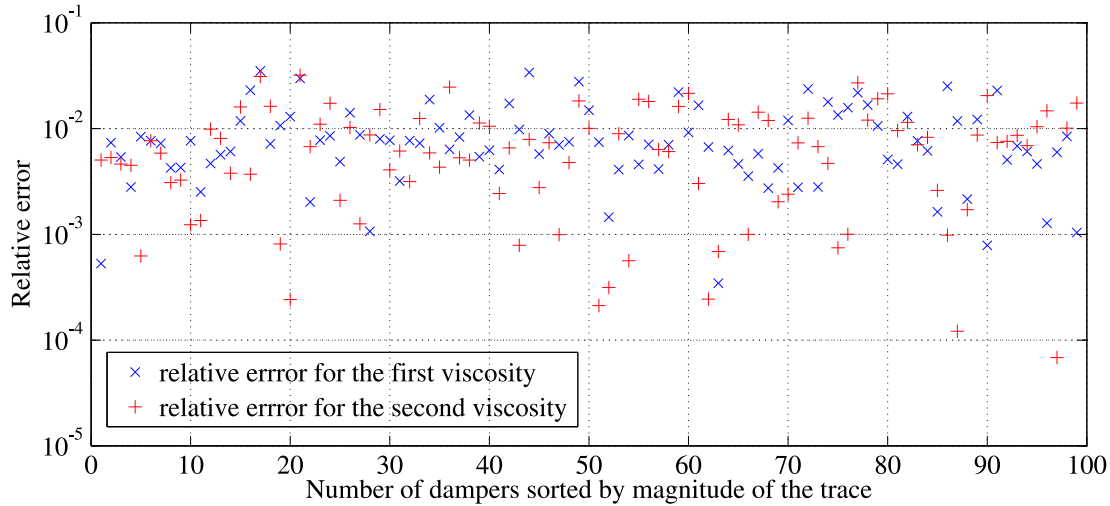

Figure 3.3: Relative errors for the optimal viscosities

Dimension of the reduced system varies in optimization procedure thus we present time ratio for this example. In Figure 3.4 we compare the times required by each of the algorithms. This figure shows the time ratio for calculating the optimal viscosities at given dampers' positions using the new algorithm and using the algorithm without dimension reduction. Times were calculated using an Intel(R) Core(TM) i7 CPU 920 with 12GB of RAM and 8 MB cache.

For example, at the optimal dampers' positions, the algorithm without dimension reduction have needed 5.726 hours to calculate optimal viscosities while the new algorithm have only needed 0.42 minutes on the same computer. This means that the new algorithm is faster by a factor of 818. From Figure 3.4 we can also see that there are numerous positions with similar time ratio which in global give much shorter time for computation.

Following example illustrates similar performance of the dimension reduction approach on the example with three rows of masses.

Example 3.2. We will consider vibrational system which is described in Example 2.1 (see Figure 2.2). Recall that the damping matrix is

$$D = C_u + C_{ext}, \quad \text{where the internal damping } C_u \text{ is defined as in (1.3).}$$

Since we will consider two dampers of different viscosity we have that external damping is defined by $C_{ext} = v_1 e_i e_i^T + v_2 e_j e_j^T$, where $1 \leq i < j \leq n$.

In Example 3.2 we will consider the following configuration:

$$\begin{aligned} d &= 400, & n &= 3d + 1 = 1201; \\ m_i &= i, & i &= 1, \dots, n; \\ k_1 &= 1, & k_2 &= 20, & k_3 &= 40, & k_4 &= 50. \end{aligned}$$

Similarly to the previous example we would like to damp all the eigenfrequencies of the undamped system, which are smaller than 0.005 by magnitude. For the above configuration this implies that $s = 14$, where s determines the matrix G from Equation (3.1).

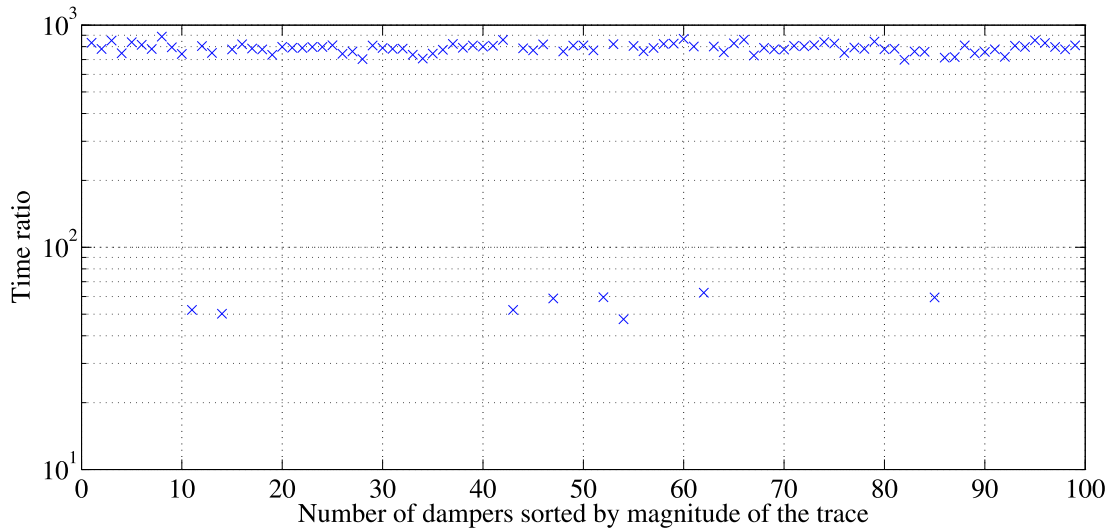

Figure 3.4: time ratio

For the sake of comparison, instead of performing viscosity optimization in all dampers' positions, we will compare the new algorithm with the standard algorithm on the equidistant mesh of dampers' positions

$$i = 34 : 50 : n, \quad j = i + 33 : 100 : n \quad (3.27)$$

which will gives 144 different dampers' positions. As in the previous example, for the purpose of better illustration of obtained results we will restrict our comparison on the data which corresponds to the 79 smallest traces (sorted by magnitude).

We have used the following configuration in Algorithm 3.3.1 (the undamped eigenfrequencies are sorted such that $\omega_1 < \omega_2 < \dots < \omega_n$):

$$\begin{aligned} \alpha_c &= 0.002; & \kappa &= 10^4; \\ p(i) &= i, i = 1, \dots, s; & \hat{s} &= 30; \\ \varepsilon &= 0.1; & tol_{start} &= 0.005; \\ c_1 &= 0.5; & v_1^0 &= v_2^0 = 50. \end{aligned}$$

Like in the previous example, viscosity was optimized with MATLAB function `fminsearch`, with the same tolerances (0.1 is the termination tolerance for function value and 0.001 for the optimization variable).

With both algorithms (with and without dimension reduction) we obtain the same optimal position (at mesh given by (3.27)) and this is the position $(i, j) = (84, 517)$ with optimal viscosities $(v_1, v_2) = (16.52987, 149.93077)$, at this position optimal trace is $\text{trace}(X(v_1, v_2)) = 706\,752.97633$.

Figures 3.5-3.7 present comparison between results obtained with the new algorithm and the standard approach. In these figures we have plotted the data which corresponds to the 79 smallest traces sorted by magnitude. The first data point corresponds to the optimal position which is given above, these positions correspond to the smallest trace.

Relative errors for optimal trace at the given dampers' positions are shown in Figure 3.5. Similarly as in the previous example, the relative errors for the trace are calculated using $|\text{trace } X - \text{trace } \tilde{X}_{11}| / \text{trace } X$, where $\text{trace } X$ is the optimal trace for the given position obtained with the algorithm without dimension reduction, and $\text{trace } \tilde{X}_{11}$ is the approximation of the optimal trace calculated by Algorithm 3.3.1.

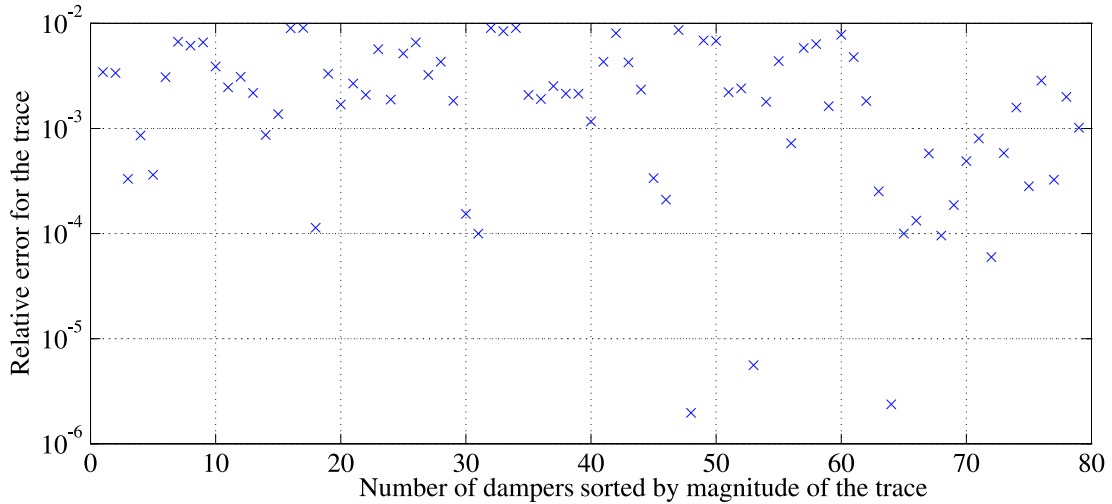

Figure 3.5: Relative error for the trace

Similarly, Figure 3.6 shows the relative errors for the first and the second optimal viscosity. The relative error for i th viscosity ($i = 1, 2$) is calculated as $|\tilde{v}_i^{opt} - v_i^{opt}| / v_i^{opt}$, where \tilde{v}_i^{opt} is the i th optimal viscosity obtained by Algorithm 3.3.1 and v_i^{opt} is the i th exact optimal viscosity obtained by optimization without dimension reduction.

Figure 3.7 shows the time ratio for calculating the optimal viscosities at given dampers' positions using the new algorithm and using the algorithm without dimension reduction. Times were calculated using an Intel(R) Core(TM)2 Duo CPU E7300, 2.00 GB of RAM.

For example, at the optimal dampers' positions, the algorithm without dimension reduction have needed 3.809 hours to calculate optimal viscosities while

the new algorithm is faster by a factor of 709.33. From Figure 3.7 we can see that there are numerous positions with similar time ratio which in global give much shorter time for computation.

Remark 3.4.1. *From the above numerical examples, we can conclude that in the case of damping of the selected eigenfrequencies (see Figures 3.4 and 3.7), the time ratio is much better than in the case of damping of all eigenfrequencies (see Figure 2.5). We have expected this effect, because of the small rank of the right-hand side of the Lyapunov equation (3.2), which has strong influence on the solution of the corresponding Lyapunov equation. Note that, the decay in the magnitude, of the diagonal elements of our solution of the corresponding Lyapunov equation, is much stronger if the right-hand side of the Lyapunov equation has small rank.*

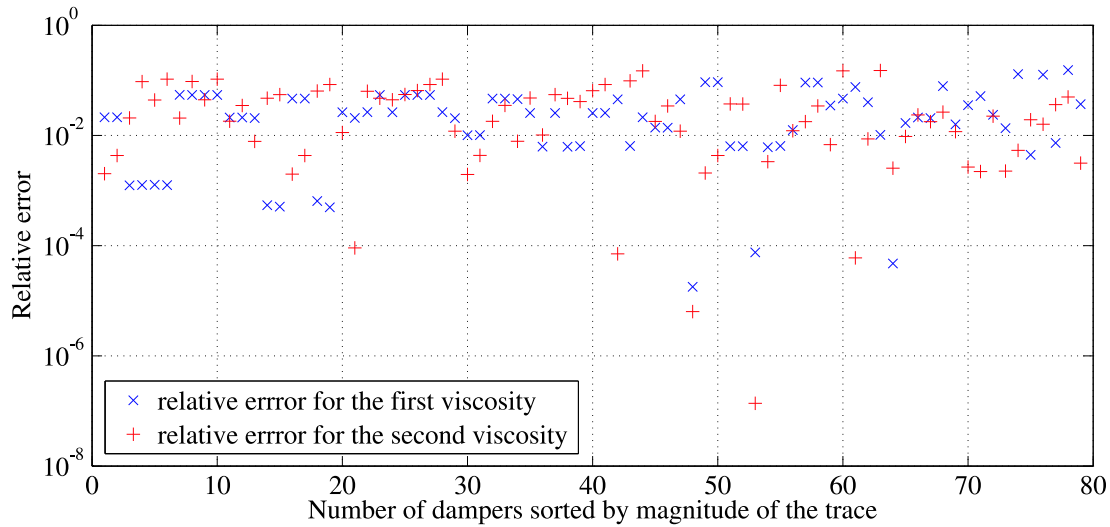

Figure 3.6: Relative errors for the optimal viscosities

3.5 Conclusions

Damping optimization in a mechanical vibrating system is a very demanding problem due to the numerous Lyapunov equations which have to be solved. In this chapter, we have considered the case when just a certain part of the spectrum has to be damped (the critical part). In this case, the right-hand side of the considered Lyapunov equation has a small rank, thus we propose a new algorithm for dimension reduction which uses this property and also exploits the structure of the system. An error bound obtained from perturbation theory is employed to determine which part of the matrix can be neglected in order to have a good approximation of the trace by solving a Lyapunov equation of much smaller size. Numerical experiments confirm the efficiency of the new algorithm for viscosity optimization, which considerably accelerates the optimization process, while ensuring that we still find the optima within the limit of tolerance.

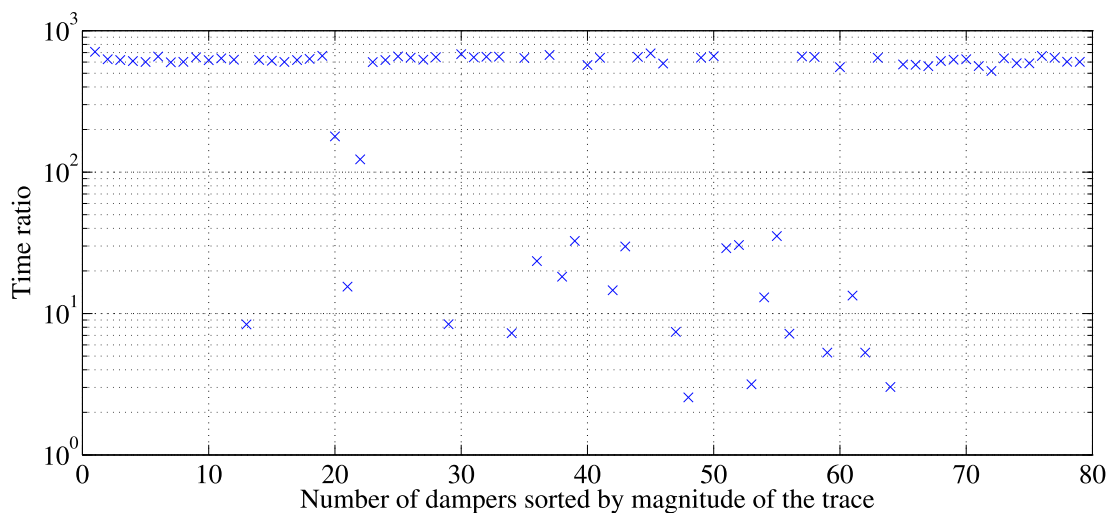

Figure 3.7: time ratio

Chapter 4

Determination of the optimal dampers' positions

Throughout this thesis we try to determine optimal damping. In this chapter we will present results on determination of optimal damping which includes optimal dampers' positions as well as corresponding viscosities.

Let the external damping is given by

$$C_{ext} = v_1 e_{i_1} e_{i_1}^T + v_2 e_{i_2} e_{i_2}^T + \cdots + v_k e_{i_k} e_{i_k}^T \quad (4.1)$$

where i_j , $j = 1, \dots, k$ corresponds with dampers' positions with viscosities v_j , $j = 1, \dots, k$. It yields directly from Equation (4.1) that it is sufficient to find optimal positions such that $1 \leq i_1 < i_2 < \dots < i_k \leq n$. Since we are interested in determination of the optimal dampers' positions and viscosities, we will use a new notation for the trace X which is now the function of dampers' positions (i_1, \dots, i_k) and corresponding viscosities (v_1, \dots, v_k) . Thus, let $X(C(v_1, \dots, v_k; i_1, \dots, i_k))$ be the solution of the Lyapunov equation

$$A X(C(v_1, \dots, v_k; i_1, \dots, i_k)) + X(C(v_1, \dots, v_k; i_1, \dots, i_k)) A^T = -Z, \quad (4.2)$$

where (i_1, \dots, i_k) are dampers' positions and (v_1, \dots, v_k) corresponding viscosities. Similarly to previous chapters, the matrix Z determines which part of the undamped eigenfrequencies has to be damped. Matrix A is equal to

$$A = \begin{bmatrix} 0 & \Omega \\ -\Omega & -\alpha\Phi^T C_{crit}\Phi - C(v_1, \dots, v_k; i_1, \dots, i_k) \end{bmatrix}, \quad (4.3)$$

where

$$C(v_1, \dots, v_k; i_1, \dots, i_k) = \Phi^T C_{ext}\Phi = \Phi^T (v_1 e_{i_1} e_{i_1}^T + v_2 e_{i_2} e_{i_2}^T + \dots + v_k e_{i_k} e_{i_k}^T) \Phi \quad (4.4)$$

and Φ is the matrix which simultaneously diagonalizes the pair (M, K) .

For a given mass matrix M , stiffness matrix K , internal damping C_u and k dampers, we are interested in determination of the optimal positions and corresponding viscosities such that the total energy of the system is minimal. In this chapter by total energy we imply the total energy used in criterion (1.14). Recall that total energy is obtained in the Introduction with described averaging. In terms of new notations, the total energy for given viscosities (v_1, \dots, v_k) and dampers' positions (i_1, \dots, i_k) is equal to trace $X(C(v_1, \dots, v_k; i_1, \dots, i_k))$ obtained as the trace of the solution of the Lyapunov equation (4.2).

Then, the optimal viscosities and dampers' positions are given by

$$(v_1^{opt}, \dots, v_k^{opt}; i_1^{opt}, \dots, i_k^{opt}) = \underset{\substack{1 \leq i_1 < i_2 < \dots < i_k \leq n \\ (i_1, \dots, i_k) \in \mathbb{N}^k \\ (v_1, \dots, v_k) \in \mathbb{R}_+^k}}{\arg \min} \text{trace } X(C(v_1, \dots, v_k; i_1, \dots, i_k)).$$

If we consider k different dampers with the same viscosity, then for external damping we have $C_{ext} = v(e_{i_1} e_{i_1}^T + e_{i_2} e_{i_2}^T + \dots + e_{i_k} e_{i_k}^T)$, and let the corresponding solution of the Lyapunov equation be $X(C(v; i_1, \dots, i_k))$.

In the next section we will present main difficulties in the process of damping optimization.

4.1 Optimization of dampers' positions

This section will be mainly devoted to the calculation of the optimal dampers' positions. The problem of determining optimal damping is extremely demanding, because numerous Lyapunov equations have to be solved. We will illustrate the complexity of damping optimization on an n -mass oscillator presented in Example 1.1 with n masses, $n + 1$ springs (see Figure 1.2) and two dampers of the same viscosity. The optimization problem includes determination of the optimal positions i, j and viscosity v , such that $\text{trace}(X(C(v; i, j)))$ is minimal. Recall that external damping is given by:

$$C_{ext} = ve_i e_i^T + ve_j e_j^T, \quad 1 \leq i < j \leq n. \quad (4.5)$$

This damping optimization with 2 dampers of the same viscosity leads to the problem of discrete optimization over $n(n - 1)/2$ different positions. One approach to determination of optimal dampers' positions is the "Direct" approach, which includes viscosity optimization for all positions for the configuration (4.5), then the optimal positions are these positions which correspond to minimal trace X . Thus, if we use the "Direct" approach, then for each configuration of dampers' positions we have to calculate optimal viscosity and for this we need to solve Lyapunov equations of dimension $2n \times 2n$ around 15 times (for the dampers of the same viscosity). This means that for external damping defined in (4.5), for example if $n = 1000$, we have to solve more than 7 million Lyapunov equations with matrices of dimension 2000.

On the other hand, for systems with larger dimensions, even solving Lyapunov equations with direct solvers (such as Bartels-Stewart algorithm) becomes very demanding. This can be accelerated with algorithms based on iterative solvers like ADI methods (for example see [8; 53; 60]). Still there is a large number of Lyapunov equations which have to be solved, and this makes optimization very demanding.

Generally, the "Direct" approach for determination of the optimal dampers' positions and corresponding viscosities is given in Algorithm 4.1.1.

Algorithm 4.1.1 ("Direct" approach for determination of optimal damping)

```

1: for  $i_1 = 1 : n$  do
2:   for  $i_2 = i_1 + 1 : n$  do
3:     ...
4:     for  $i_k = i_{k-1} + 1 : n$  do
5:       calculate optimal viscosities
        $(v_1^{opt}, \dots, v_k^{opt}) = \arg \min_{(v_1, \dots, v_k) \in \mathbb{R}_+^k} \text{trace } X(C(v_1, \dots, v_k; i_1, \dots, i_k))$ 
6:       calculate  $\text{trace } X(C(v_1^{opt}, \dots, v_k^{opt}; i_1, \dots, i_k))$ 
7:     end for
8:   end for
9: end for
10: end for
11: Optimal positions  $i_1^{opt}, \dots, i_k^{opt}$  are the positions that correspond to the
    minimal value calculated in Step 6 (corresponding viscosities are the op-
    timal ones).

```

As described above, efficient determination of optimal damping is very demanding due to numerous Lyapunov equations which have to be solved. Furthermore, this problem is demanding since our penalty function, which has to be minimized, has many local minima. In order to illustrate difficulties, which arise in the optimization process, we will consider the following example.

Example 4.1. Consider the n -mass oscillator from Example 1.1 with the following configuration:

$$\begin{aligned}
n &= 400; \\
m_i &= 500 + \frac{5}{2}(101 - i), \quad \text{for } i = 1, \dots, 100; \\
m_i &= 5 \cdot i, \quad \text{for } i = 101, \dots, n; \\
k_i &= 8, \forall i; \\
D &= 0.001 \cdot C_{crit} + C_{ext}, \quad \text{where } C_{crit} \text{ is given by (1.3);} \\
C_{ext} &= v e_i e_i^T + v e_j e_j^T, \quad 1 \leq i < j \leq n.
\end{aligned} \tag{4.6}$$

In this example our aim is to damp all undamped eigenfrequencies, thus $s = n$.

In Figure 4.1 and 4.2 we have presented the function

$$(i, j) \mapsto \min_v \text{trace}(X(C(v; i, j)))$$

for i, j such that $1 \leq i < j \leq n$. Matrix $X(C(v; i, j))$ is defined in Equation (4.2) and the trace of the matrix $X(C(v; i, j))$ represents the total energy of the system at the optimal viscosity for the position (i, j) . Figure 4.1 shows a surface plot where the first damper's position i is represented on the x -axis, the second damper's position j is represented on the y -axis while z -axis represents the value of the plotted function. Contour plot of the same function is presented in Figure 4.2. From these figures it can be seen that our penalty function has many local minima (where some of them are very close).

In Figure 4.2 the black circle represents the optimal position obtained by the "Direct" approach described in Algorithm 4.1.1. This corresponds to the position $(i, j) = (115, 280)$ with corresponding optimal viscosity 144.93268, which yields to the trace of the Lyapunov equation $\text{trace}(X(C(144.93268; 115, 280))) = 1995235.75057$. It is important to note that if we sort the minimal total energies (at given dampers' positions), by the magnitude, we will see that 36 of them are close to the optimal one since the relative error (with respect to optimal) is less than 0.005. These 36 positions are plotted in Figure 4.2 using a blue dots. Optimal viscosity at each position was calculated using the MATLAB function `fminbnd` with termination tolerances for the viscosity and for the function values equal to 10^{-4} (this will give relative error which is less than 10^{-10}). Note that for Algorithm 4.1.1 we have needed to solve 1 195 278 Lyapunov equations.

In the next section we will show that for some cases, even with the "Direct" approach, we can efficiently determine optimal damping.

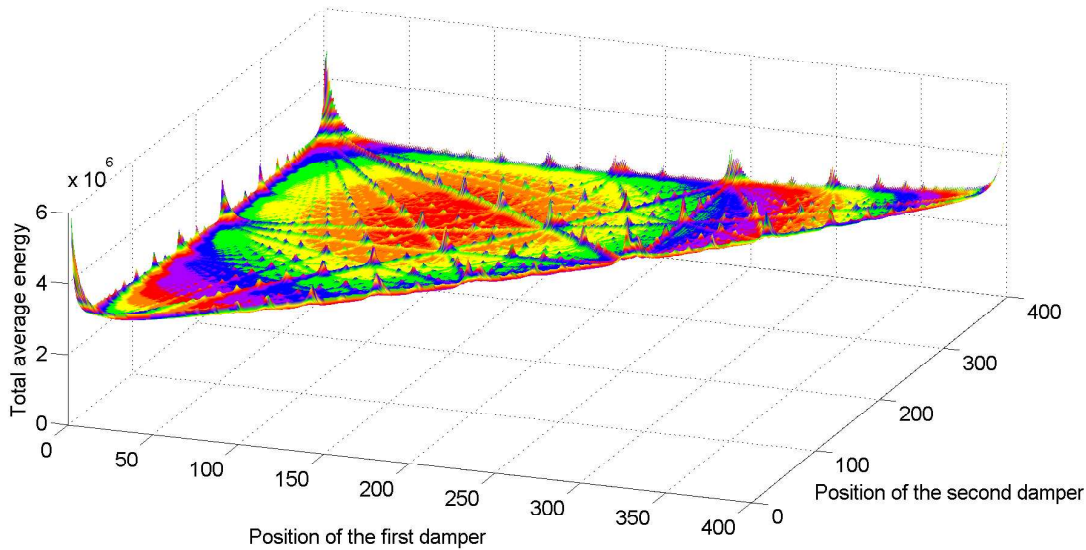

Figure 4.1: Surface plot of the function $(i, j) \mapsto \min_v \text{trace}(X(C(v; i, j)))$

4.1.1 Determination of optimal damping for a one-dimensional case

In this section we will consider the case of damping where the trace of the Lyapunov equation is given by a formula, thus viscosity optimization can be performed very efficiently. We are interested in optimal damping of a system without internal damping ($C_u = 0$) and with one damper that yields to a damping matrix D which is the rank 1 matrix (thus we call it a one-dimensional case). Then in Algorithm 4.1.1 we have to find an optimal position i which requires n viscosity optimizations that have to be calculated in Step 5 of Algorithm 4.1.1.

This can be done very efficiently by using the formula for the trace of the corresponding Lyapunov equation, for more details see [14; 57]. Then the optimal viscosity can be calculated with a simple formula

$$\text{trace}(X(v)) = c + \frac{a}{v} + bv \quad (4.7)$$

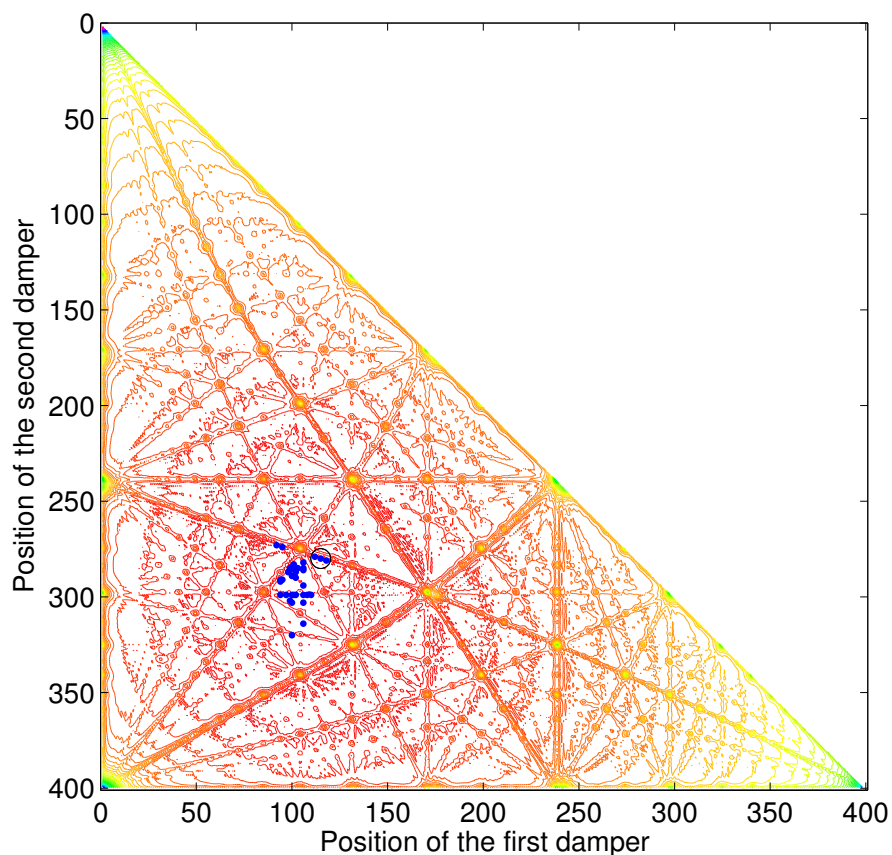

Figure 4.2: Contour plot of the function $(i, j) \mapsto \min_v \text{trace}(X(C(v; i, j)))$

where v is viscosity which has to be optimized, $X(v)$ is the corresponding Lyapunov solution and $a, b > 0$ and c are constants depending on M, K only. Now, the optimal viscosity v_{opt} is given by

$$v_{opt} = \sqrt{\frac{a}{b}}. \quad (4.8)$$

If we damp all undamped eigenfrequencies, with internal damping being equal to zero, for the above mentioned parameters a, b and c from [14, Lema 4.3] it

yields

$$\begin{aligned}
 a &= \sum_{i=1}^n \frac{2}{c_i^2}, \quad c = 0, \\
 b &= \sum_{i=1}^n \sum_{\substack{j=1 \\ j \neq i}}^n \frac{3\omega_i^2 c_j^2 + c_i^2 \omega_i^2}{(\omega_i^2 - \omega_j^2)^2} + \sum_{i=1}^n \frac{2\omega_i^2}{c_i^2} \left(\sum_{\substack{k=1 \\ k \neq i}}^n \frac{c_k^2}{\omega_k^2 - \omega_i^2} \right)^2 \\
 &\quad + \sum_{i=1}^n \frac{c_i^2}{2\omega_i^2} + \sum_{i=1}^n \sum_{\substack{j=1 \\ j \neq i}}^n \frac{\omega_j^2 (c_j^2 + c_i^2)}{(\omega_i^2 - \omega_j^2)^2}.
 \end{aligned}$$

From the above, we can conclude that optimization in Step 5 of Algorithm 4.1.1 can be calculated very efficiently. This makes even the "Direct" approach applicable for moderate dimensions (where dimension n is few thousands and a simultaneous diagonalization of a pair (M, K) can be performed).

Example 4.2. *We will illustrate optimization using a formula and the "Direct" approach to an n -mass oscillator introduced in Example 3.1 (the system is given in Figure 3.1). We will use the same configuration for masses and stiffnesses given in (3.25). Our aim is to apply results from [57], thus we take internal damping to be zero ($C_u = 0$). Furthermore, we have one damper giving that the damping matrix is defined with $D = v e_i e_i^T$. In this example, we will damp all the undamped eigenfrequencies which means that the matrix Z from Equation (4.2) is equal to identity.*

We will use Algorithm 4.1.1 for determination of optimal viscosity and damper's position. In Step 5 and 6 we use formula (4.8) for calculation of optimal viscosity v_{opt} and the corresponding trace is given by Equation (4.7). Using this algorithm we will obtain that the optimal viscosity is equal to 335.39265 and the optimal damper's position is equal to 90. The trace of the Lyapunov equation for optimal damping is equal to $1.24291 \cdot 10^9$. Instead of using Algorithm 4.1.1, we can accelerate the optimization process using heuristic that will be presented in the next section.

One generalization of the optimization problem with two dampers of the same viscosity will be considered in Section 4.6, where we will give a similar, but

much more complicated formula for the trace of the Lyapunov equation. This formula is not explicit, as in a one-dimensional case described above, since an additional linear system has to be solved for each calculation of the trace of the Lyapunov equation. In the case of two dampers' positions, the number of different positions is larger and then the "Direct" approach can be accelerated with a heuristic which will be introduced in the following section.

Since generally the "Direct" approach is computationally very demanding, we will propose approaches where some of them rely on heuristics that efficiently calculate the approximation of optimal damping. The first one is the "Multigrid-like" approach which is introduced in the next section.

4.2 The "Multigrid-like" optimization approach

In this section we will present the "Multigrid-like" heuristic for the determination of the optimal dampers' positions. One version of this algorithm is also given in [51].

The basic idea of the "Multigrid-like" approach is that we first calculate optimal viscosities for some grid of the dampers' positions, that is sparsely distributed over the set of admissible dampers' positions. Then, around the best positions we refine the grid and continue searching for the optimal positions.

Before we describe our ideas in detail we will introduce some notations. Let d_1 be the step that determines how fine the first grid will be (the first grid is defined in Steps 1 to 4 of Algorithm 4.2.1). Similarly, let d_2 be the parameter which determines the second grid (the second grid is defined in Steps 12 to 15 of Algorithm 4.2.1). The "Multigrid-like" approach is presented in Algorithm 4.2.1.

In Algorithm 4.2.1, in Steps 12 to 15, we have min and max terms in order to ensure that $1 \leq i_1 < i_2 \leq n$.

Algorithm 4.2.1 ("Multigrid like" approach for determination of optimal damping)

Input: d_1, d_2 – parameters that determine the first and the second grid;

Output: Optimal dampers' positions $i_1^{opt}, \dots, i_k^{opt}$ and optimal viscosities $v_1^{opt}, \dots, v_k^{opt}$.

- 1: **for** $i_1 = 1 + d_2 : d_1 : n$ **do**
 - 2: **for** $i_2 = i_1 + d_2 : d_1 : n$ **do**
 - 3: \dots
 - 4: **for** $i_n = i_{k-1} + d_2 : d_1 : n$ **do**
 - 5: calculate optimal viscosities
 $(v_1^{opt}, \dots, v_k^{opt}) = \arg \min_{(v_1, \dots, v_k) \in \mathbb{R}_+^k} \text{trace } X(C(v_1, \dots, v_k; i_1, \dots, i_k))$
 - 6: calculate trace $X(C(v_1^{opt}, \dots, v_k^{opt}; i_1, \dots, i_k))$
 - 7: **end for**
 - 8: \dots
 - 9: **end for**
 - 10: **end for**
 - 11: Denote positions that correspond to the minimal value calculated in Step 6 with $(\hat{i}_1, \dots, \hat{i}_k)$.
 - 12: **for** $i_1 = \max\{\hat{i}_1 - d_2, 1\} : \min\{\hat{i}_1 + d_2, n\}$ **do**
 - 13: **for** $i_2 = \max\{\hat{i}_2 - d_2, i_1 + 1\} : \min\{\hat{i}_2 + d_2, n\}$ **do**
 - 14: \dots
 - 15: **for** $i_k = \max\{\hat{i}_{k-1} - d_2, i_{k-1} + 1\} : \min\{\hat{i}_{k-1} + d_2, n\}$ **do**
 - 16: calculate optimal viscosities
 $(v_1^{opt}, \dots, v_k^{opt}) = \arg \min_{(v_1, \dots, v_k) \in \mathbb{R}_+^k} \text{trace } X(C(v_1, \dots, v_k; i_1, \dots, i_k))$
 - 17: calculate trace $X(C(v_1^{opt}, \dots, v_k^{opt}; i_1, \dots, i_k))$
 - 18: **end for**
 - 19: \dots
 - 20: **end for**
 - 21: **end for**
 - 22: Optimal positions $i_1^{opt}, \dots, i_k^{opt}$ are the positions that correspond to the minimal value calculated in Step 17 (corresponding viscosities are the optimal ones).
-

Remark 4.2.1. *Optimal parameters d_1 and d_2 should be determined in order to reduce the number of equations which have to be solved. For the sake of determination of optimal parameters d_1 and d_2 , we suppose the following:*

- *at given damper positions we have a constant number of evaluations in order to determine optimal viscosity (usually this number does not vary too much);*
- *we take that $d_2 = \lfloor p_d \cdot d_1 \rfloor$, where p_d is a ratio that determines d_2 in terms of d_1 , for example $p_d = \frac{2}{3}$;*
- *suppose that $(\hat{i}_1, \dots, \hat{i}_k)$ is not too close to the edge of the area where optimization is performed. This assumption is in order to estimate the number of evaluations needed for generating the second mesh.*

Now, for a given number of masses n , a number of dampers k and p_d , we can determine d_1 such that a number of function evaluations is minimal. For configuration (4.6), this will give that $d_1 = 13$ and $d_2 = 8$.

Example 4.3. *In order to show the advantage of the "Multigrid-like" optimization approach we will compare this method with the approach that uses the "Direct" approach defined in Algorithm 4.1.1. For that purpose we will again consider Example 4.1.*

Using Remark 4.2.1, for $p_d = 2/3$ we will obtain that $d_1 = 13$ and $d_2 = 8$. At given dampers' positions optimal viscosity was calculated using the MATLAB function `fminbnd` with termination tolerances for viscosity and for function values equal to 10^{-4} . With the "Multigrid-like" optimization approach we needed 11284 of function evaluations, which is less than 1% of the total number of evaluations needed in the "Direct" approach. An optimal position using the Multigrid-like optimization approach is equal to (101, 299) and that is not so close to the optimal one. However, this is the one of the local minima whose total energy is close to the optimal total energy, that is, the relative error for the corresponding trace is equal to 0.001894. Moreover, if we sort local minima by magnitude of the total energy, then, this optimal position corresponds

to the 4th smallest energy. Note that the total number of positions is equal to 79800.

In Figure 4.3 we have illustrated optimal values and grids generated during the optimization process. More precisely, the optimal position calculated by Algorithm 4.1.1 was denoted by a black circle, points of the grid generated in Steps 1 to 4 of Algorithm 4.2.1 were plotted using green \times -es, points of the grid generated in Steps 12 to 15 of Algorithm 4.2.1 were plotted using blue dots and the optimal position calculated with Algorithm 4.2.1 was denoted by a black star.

The "Multigrid-like" approach can also be used in the case of one-dimensional damping, which was considered in the previous section. In Example 4.2, we have shown that optimal damping can be determined by the "Direct" approach where viscosity was optimized by the formula (4.7). Now, we can additionally accelerate the optimization process with the "Multigrid-like" approach.

For the purpose of illustration we will consider Example 4.2. For determination of optimal damping we will use Algorithm 4.2.1 where in Steps 5 and 16 we will calculate optimal viscosity with formula (4.7). Similarly to the above, using Remark 4.2.1 for $p_d = 2/3$, we will obtain that $d_1 = 34$ and $d_2 = 22$. Now, with this approach we will obtain that optimal damper's position is equal to 90 with the corresponding viscosity 335.39265. Note that the optimal parameters are the same as the ones obtained using the "Direct" approach. Recall that with the "Direct" approach we needed to optimize viscosity for 1600 damper's positions, while with the "Multigrid-like" approach we needed to optimize viscosity for just 92 damper's positions. Thus, we have additionally accelerated the optimization process and we have obtained the same optimal damping.

Note that for the Lyapunov equations of a bigger dimension, we use optimal parameters d_1 and d_2 (see Remark 4.2.1) in Algorithm 4.2.1, but the number

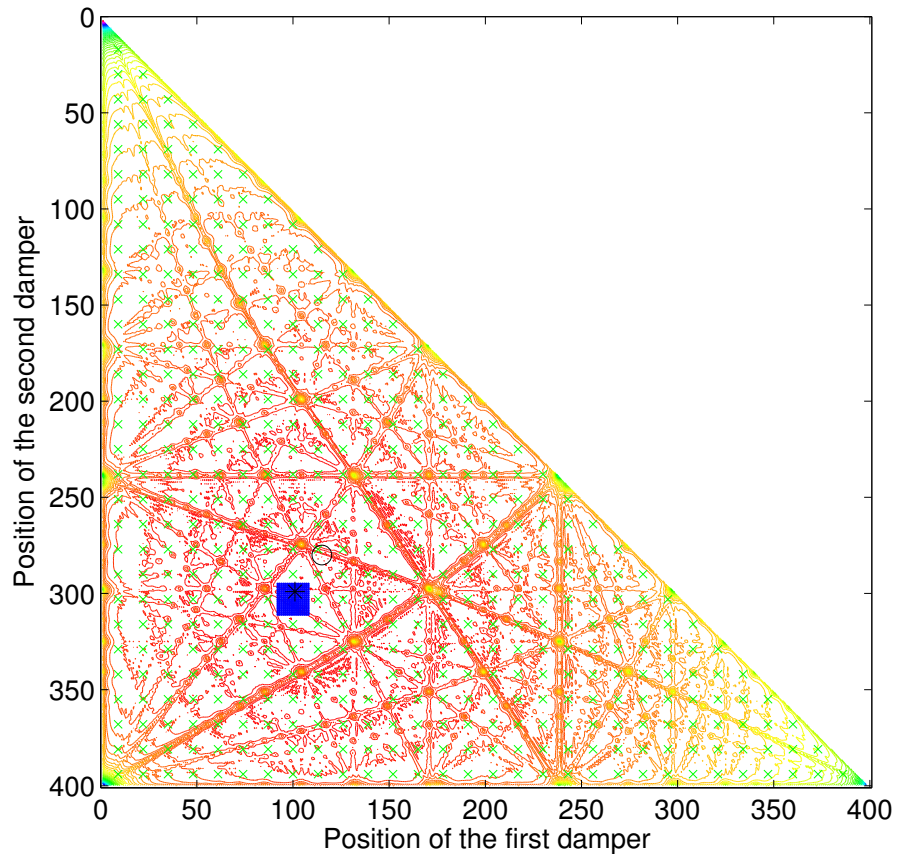

Figure 4.3: Contour plot of the function $(i, j) \mapsto \min_v \text{trace}(X(C(v; i, j)))$ and data from the "Multigrid-like" approach

of Lyapunov equations which have to be solved can be large. Thus in the next section we propose another heuristic approach which will also have a good performance on numerical examples. Furthermore, with this approach we can additionally reduce the number of Lyapunov equations which have to be solved.

4.3 The "Discrete to continuous" optimization approach

The "discrete to continuous" heuristical approach relies on the optimization of the function of real variables. First we will define an additional function which will be used in the optimization procedure. We want to determine optimal damping for k dampers with different viscosities. Thus, for $\mathcal{D} \subset \mathbb{R}^{2k}$ we define a function $f : \mathcal{D} \rightarrow \mathbb{R}$ with

$$f(v_1, \dots, v_k; i_1, \dots, i_k) = \text{trace}(X(C(v_1, \dots, v_k; [i_1], \dots, [i_k]))), \quad (4.9)$$

where $[\cdot]$ stands for the rounding (we have used MATLAB function `round`) and the matrix $X(C(v_1, \dots, v_k; [i_1], \dots, [i_k]))$ is the solution of the Lyapunov equation (4.2). Here i_k is considered as a continuous variable and dampers' positions $[i_1], [i_2], \dots, [i_k]$ with corresponding viscosities v_1, v_2, \dots, v_k determine C .

Now, we reduce our optimization problem to minimization of the function (4.9). Thus, for minimization of this function we can use standard methods like Nelder-Mead or, for example, Newton like methods. When we determine the minimum of the function (4.9) we will denote the point where the minimum is achieved with $(\hat{v}_1, \hat{v}_2, \dots, \hat{v}_k; \hat{i}_1, \hat{i}_2, \dots, \hat{i}_k)$. Then optimal positions are $[\hat{i}_1], [\hat{i}_2], \dots, [\hat{i}_k]$ with corresponding optimal viscosities equal to $\hat{v}_1, \hat{v}_2, \dots, \hat{v}_k$.

Apart from the above mentioned minimization procedure like the Nelder-Mead method (implemented in the MATLAB function `fminsearch`) or the Newton-like methods (implemented in the MATLAB function `fmincon` or `fminunc`), one can also use a genetic algorithm (implemented in the MATLAB function `ga`). In the optimization process we will use the Nelder-Mead method which is much more robust than the other mentioned methods for our minimization problem. A further question in minimization with a Nelder-Mead method are starting points and for that we will define a grid of starting points for dampers' positions, which will correspond to starting points generated in Steps 1 to 4

of Algorithm 4.3.1. Some fixed points $\widehat{v}_1^s, \widehat{v}_2^s, \dots, \widehat{v}_k^s$ will be taken for starting viscosities.

First, we have to define parameters d_3 and d_4 which determine the grid of starting points (i_1^s, \dots, i_k^s) .

Algorithm 4.3.1 ("Discrete to continuous" approach for determination of optimal positions)

Input: d_3, d_4 – parameters which determine the first and the second grid;

Output: Optimal dampers' positions $i_1^{opt}, \dots, i_k^{opt}$ and optimal viscosities $v_1^{opt}, \dots, v_k^{opt}$.

```

1: for  $i_1^s = 1 + d_4 : d_3 : n - d_4$  do
2:   for  $i_2^s = i_1^s + d_4 : d_3 : n - d_4$  do
3:     ...
4:     for  $i_k^s = i_{k-1}^s + d_4 : d_3 : n - d_4$  do
5:       Using starting points  $(v_1^s, \dots, v_k^s; i_1^s, \dots, i_k^s)$ 
         calculate (for example with Nelder-Mead)
           
$$\min_{\substack{(v_1, \dots, v_k) \in \mathbb{R}_+^k \\ 1 \leq i_1 < i_2 < \dots < i_k \leq n \\ (i_1, \dots, i_k) \in \mathbb{N}^k}} f(v_1, \dots, v_k; i_1, \dots, i_k).$$

6:       end for
7:     ...
8:   end for
9: end for
10: Parameters which correspond to the minimal value calculated in Step 5
     determine optimal parameters  $(v_1^{opt}, \dots, v_k^{opt}; i_1^{opt}, \dots, i_k^{opt})$ , where  $i_j^{opt} = [i_j]$ ,  $j = 1, \dots, k$ .
```

As can be seen from Algorithm 4.3.1, the parameter d_3 determines the difference between points inside the region where optimal position is to be found, while the parameter d_4 defines the distance to the edge of the region where the optimal position is to be found.

Example 4.4. *In this example we will present performance of the "Discrete to continuous" optimization approach on Example 4.1. First, we will compare this method with the "Direct" approach defined in Algorithm 4.1.1 and then with the "Multigrid-like" optimization approach defined in the previous section.*

In Algorithm 4.1.1 we have used following configuration:

$$d_3 = 40;$$

$$d_4 = 20;$$

$$v^s = 100.$$

For the minimization in Step 5 of Algorithm 4.3.1 we have used MATLAB's function `fminsearch` with termination tolerances for variables and for function values equal to 10^{-4} . With the "Discrete to continuous" optimization approach we needed 11921 function evaluations, which is slightly less than 1% of the number of evaluations needed in the "Direct" approach. Compared to the "Multigrid-like" optimization approach, the number of function evaluations has a relatively similar order of magnitude. The optimal position here is equal to (118, 281) and this is also one of the local minima whose total energy is close to the optimal one, that is, the relative error is equal to 0.0037584. If we sort local minima by magnitude of the total energy, then this optimal position corresponds to the 15th position which is a good approximation, since the total number of positions is equal to 79800.

In Figure 4.4 we have illustrated optimal values and a grid generated during the optimization process. All this is plotted on the contour plot given in Figure 4.2. The optimal position calculated with Algorithm 4.1.1 was denoted by a black circle, the grid of the starting points generated in Steps 1 to 4 of Algorithm 4.2.1 was plotted using blue pluses, and the optimal position calculated with Algorithm 4.3.1 was denoted by a blue triangle.

Remark 4.3.1. *Nelder-Mead [40] is an unconstrained multidimensional optimization method. In numerical experiments the optimization procedure could require an evaluation at the points that are not in domain (for example, viscosity becomes negative). Thus, at points that are outside domain (where optimization is performed) in our optimization procedure we have set the function value to some constant large enough. With this, our optimization procedure*

will always return a minimum which is inside the domain of our function that has to be minimized.

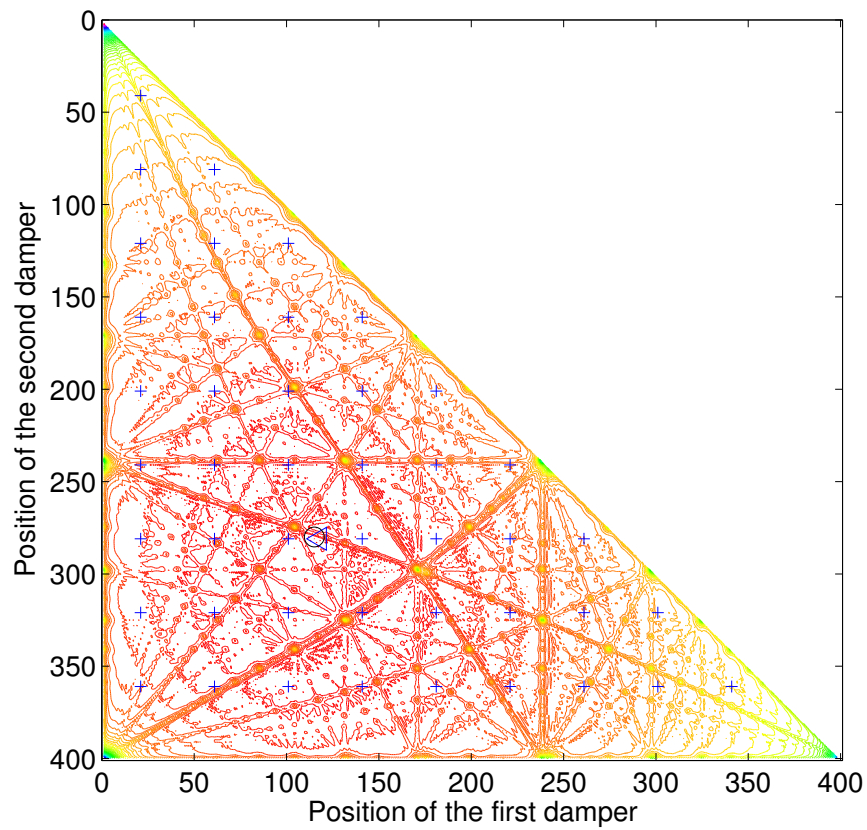

Figure 4.4: Contour plot of the function $(i, j) \mapsto \min_v \text{trace}(X(C(v; i, j)))$ and data from the "Discrete to continuous" approach

4.4 Damping optimization based on dimension reduction and continuous minimization

In previous sections we have introduced approaches which optimize dampers' positions using heuristic approaches which can be applied to moderate or large dimensions. However, for large systems even solving the corresponding Lyapunov equation is demanding for itself. Thus, in this section we propose a new heuristic which will combine approximation algorithms with dimension reduction techniques and heuristical approaches introduced in previous sections. In the case where we damp all undamped eigenfrequencies we will use approximation algorithms introduced in Chapter 2. Contrary to this, in the case when we damp the selected part of undamped eigenfrequencies we will use algorithms derived in Chapter 3.

We will compare an approach that uses the "Multigrid-like" optimization approach described in Section 4.2 with the "Discrete to continuous" approach described in Section 4.3.

An algorithm that uses the "Multigrid-like" optimization approach can be applied directly, that is, we can apply Algorithm 4.2.1 where in Steps 5 and 16 we calculate the minimum using the corresponding algorithm with dimension reduction. In the case of damping all undamped eigenfrequencies, we will use Algorithm 2.4.1 and in the case of damping of selected eigenfrequencies, we will use Algorithm 3.3.1.

An algorithm that relies on the "Discrete to continuous" approach has to be modified. In the minimization process we cannot directly apply the existing algorithm that uses a dimension reduction, since these algorithms optimize viscosities at given damping positions, while in the "Discrete to continuous" approach we change damping positions during the optimization process. This modification includes checking of the corresponding error bound at each step of the optimization procedure. More precisely, for the approximation

of $f(v_1, \dots, v_k; i_1, \dots, i_k)$ given in Equation (4.9), we have two cases which depend on the eigenfrequencies which have to be damped.

If we damp all eigenfrequencies, in Step 5 of Algorithm 4.3.1 we need to calculate an approximation of the function $f(v_1, \dots, v_k; i_1, \dots, i_k)$ with given tolerances $\varepsilon_1, \varepsilon_2$. This approximation is given in Algorithm 4.4.1. In the following two algorithms parameter \mathbf{u} represents machine precision. For the purpose of simplification, on the input we give just parameters that are essential for the corresponding algorithm.

Algorithm 4.4.1 (Approximation of the function $f(v_1, \dots, v_k; i_1, \dots, i_k)$)

Input: $\kappa \geq 1$;

$\varepsilon_1, \varepsilon_2$ – tolerances for bounding the approximation error;

c_1 – a positive constant for scaling a tolerance ($c_1 < 1$);

Output: f_{approx} – approximation of the function $f(v_1, \dots, v_k; i_1, \dots, i_k)$.

```

1:  $tol = tol_{start}$ 
2: while  $tol > 10^4 u$  do
3:   Calculate approximation of the function  $f(v_1, \dots, v_k; i_1, \dots, i_k)$  with Algorithm 2.2.1 using tolerance  $tol$ , and denote the approximation by  $f_{approx}$ .
4:   Calculate the right-hand sides of bounds (2.31) and (2.32) for the approximation and denote them by  $b_1$  and  $b_2$ , resp.
5:   if  $b_1 < \varepsilon_1$  and  $b_2 < \varepsilon_2$  then
6:     return  $f_{approx}$ 
7:     break
8:   else
9:      $tol = c_1 \cdot tol$ 
10:  end if
11: end while

```

Similarly, in the case of damping selected eigenfrequencies, in Step 5 of Algorithm 4.3.1, we need to calculate an approximation of the function $f(v_1, \dots, v_k; i_1, \dots, i_k)$. Algorithm 4.4.2 gives an approximation with a given tolerance ε .

Note that, in Step 5 of Algorithm 4.3.1, if we minimize our penalty function for example with Nelder-Mead method, using Remark 3.3.1 we can also we improve the optimization process.

Algorithm 4.4.2 (Approximation of the function $f(v_1, \dots, v_k; i_1, \dots, i_k)$)

Input: $\kappa \geq 1$;

tol_{start} – tolerance for the first approximation;

ε – tolerance for bounding the approximation error;

c_1 – a positive constant for scaling a tolerance ($c_1 < 1$);

Output: f_{approx} – approximation of the function $f(v_1, \dots, v_k; i_1, \dots, i_k)$.

```

1:  $tol = tol_{start}$ 
2: while  $tol > 10^{4u}$  do
3:   Calculate an approximation of a function  $f(v_1, \dots, v_k; i_1, \dots, i_k)$  with
   Algorithm 3.1.2 using tolerance  $tol$ , and denote the approximation by
    $f_{approx}$ .
4:   Calculate the right-hand side of the bound (3.24) and denote it by  $b_1$ 
5:   if  $b_1 < \varepsilon$  then
6:     return  $f_{approx}$ 
7:     break
8:   else
9:      $tol = c_1 \cdot tol$ 
10:  end if
11: end while

```

In the following example we will show performance of damping optimization using approximation algorithms and heuristical approaches.

Example 4.5. *We will compare two previously described approaches on Example 3.1 with configuration (3.25). We will damp the same eigenfrequencies as in Example 3.1, thus $s = 34$, which means that we try to damp 34 smallest undamped eigenfrequencies.*

First, we will present results obtained with the "Discrete to continuous" approach presented in Algorithm 4.3.1, but in Step 5 we will use the approximation of the function given by Algorithm 4.4.2.

In Algorithm 4.3.1 we will use the following configuration:

$$d_3 = 160;$$

$$d_4 = 80;$$

$$v_1^s = v_2^s = 50.$$

Since we consider damping of selected undamped eigenfrequencies, we will use the approximation algorithm defined in Algorithm 4.4.2. In Algorithm 4.4.2 we will use the following configuration:

$$tol_{start} = 0.02;$$

$$\varepsilon = 0.05;$$

$$c_1 = 0.5.$$

Parameters d_3 and d_4 give the grid with 45 different points in Algorithm 4.3.1. The function was minimized with MATLAB's function `fminsearch` and for a termination tolerance for the function value we have taken 0.1, which determines an absolute error, thus the relative error has magnitude $\mathcal{O}(10^{-7})$. The termination tolerance for the optimization variable is set to 0.01 (this also determines the absolute error). We have obtained that the optimal dampers' positions are equal to (730, 1274) with the optimal viscosities are equal to (120.47387, 120.38917). For these parameters the value of our penalty function equals 987 258.34332. (This value was calculated using an algorithm without dimension reduction.)

For the sake of comparison of our two heuristics, now we will calculate optimal damping using the "Multigrid like" approach presented in Algorithm 4.2.1. In Steps 5 and 16 we will calculate the minimum using an algorithm with dimension reduction. Since in this example we will damp selected undamped eigenfrequencies, for the approximation we will use Algorithm 3.3.1. In Algorithm 3.3.1 we will use the following configuration:

$$\alpha_c = 0.001;$$

$$\kappa = 10^4;$$

$$p(i) = i, i = 1, \dots, s;$$

$$\widehat{s} = 60;$$

$$\varepsilon = 0.1;$$

$$tol_{start} = 0.002;$$

$$c_1 = 0.5;$$

$$v_1^0 = v_2^0 = 50.$$

Viscosities were optimized by a function `fminsearch`. For the termination tolerance for the function value we have taken 0.1, and for the termination tolerance on viscosity we have used 0.001. Recall that these tolerances correspond to absolute error. We have obtained that optimal dampers' positions are equal to (777, 1273) with optimal viscosities equal to (105.0941, 139.88212). For these parameters, the value of our penalty function is equal to 981 799.98217 (this value was calculated using an algorithm without dimension reduction). Note that with the "Multigrid-like" approach we have obtained better optimal damping (the trace of the corresponding Lyapunov equation is smaller) and relative errors at the value of our penalty function is equal to 0.0055288.

Now, we are interested in the time ratio between these two approaches (the "Multigrid-like" and the "Discrete to continuous" approach with dimension reduction) and between "Multigrid-like" approach without dimension reduction. Due to the complexity, we will just estimate the time needed for calculation of the optimal damping with the "Multigrid-like" approach without dimension reduction. For that purpose we can use results obtained in Example 3.1. In Example 3.1 for one viscosity optimization we needed 5.40589 hours on average. If we apply the "Multigrid-like" approach without dimension reduction, we estimate that we would need to calculate optimal viscosity at 19974 different dampers' positions, meaning that we would than 12 years (to complete the optimization process). If we wanted to perform the "Direct" approach described in Algorithm 4.1.1 without dimension reduction, the time needed for the calculation of optimal damping would be much longer.

On the other hand, for calculating the approximation of optimal damping with Algorithm 4.3.1 with dimension reduction (using Algorithm 4.4.2) we would need 0.532 days, while with Algorithm 4.2.1 with dimension reduction we would need 11.8782 days. Although the algorithm using the "Discrete to continuous" approach was faster, we can conclude that both approaches with dimension reduction are considerably faster than approaches that work without dimension reduction. Thus with algorithms 4.2.1 or 4.4.2 with dimension reduction techniques we have significantly accelerated the time needed for the calculation of the approximation of optimal damping. The obtained results

with corresponding times were calculated using an Intel(R) Core(TM) i7 CPU 920 with 12GB of RAM and 8 MB cache.

4.5 Area with the optimal dampers' positions

In this section we will present an algorithm for the efficient determination of the area where the optimal dampers are located. Since this method relies on the new theoretical bound, this method is not a heuristical approach as were the approaches presented in the two preceding sections. Determination of this area is possible in a system with a special structure. Using a similar approach that was used for derivation of the error bound (3.24), we could derive a similar bound that would ensure determination of dampers' positions that have negligible impact on the overall damping of the system. With this approach we avoid the viscosity optimization at some dampers' positions which can remarkably improve the efficiency of optimization algorithm.

Let τ_0 be a trace of a solution to the Lyapunov equation (4.2) for a case where external damping $C_{ext} = 0$. Using a formula given in (2.8), it is easy to show that

$$\tau_0 = \left(\frac{2}{\alpha} + \frac{\alpha}{2} \right) \sum_{i=1}^s \frac{1}{\omega_{p(i)}}, \quad (4.10)$$

where the vector p contains the indices of s eigenfrequencies that have to be damped. The aim of our algorithm is to determine dampers' positions such that trace $X(C)$ is very close to τ_0 . Thus, these dampers' positions would have no or only negligible impact on the system's energy.

Recall that the matrix of the external damping is equal to

$$C_{ext} = v_1 C_1 + v_2 C_2 + \cdots + v_k C_k,$$

where k is the number of dampers and C_i , $i = 1, \dots, k$ describes the geometry of the i th damper with the corresponding viscosity v_i (then $C = \Phi^T C_{ext} \Phi$). Now, for given dampers' positions, we consider the Lyapunov equation (4.2)

with damping C such that $C(p(i), j) = 0$, for $i = 1, \dots, s$, $j = 1, \dots, n$. Here p contains just the indices of eigenfrequencies which have to be damped and $p \cup \bar{p} = \{1, 2, \dots, n\}$. In this case $\text{trace}(X(C)) = \tau_0$.

The basic idea is to determine a damping matrix C with $\max_{\substack{1 \leq i \leq s \\ 1 \leq j \leq n}} |C(p(i), j)| \leq \varepsilon$ for some small ε , such that $\text{trace}(X(C)) \approx \tau_0$. If $\text{trace}(X(C))$ is very close to τ_0 , this would mean that these dampers' positions do not damp the system significantly. In order to efficiently determine positions where the $\text{trace}(X(C))$ is close to τ_0 , we will derive a bound from which we can determine such positions.

We will consider Equation (3.11) as a perturbed equation of:

$$\begin{bmatrix} \tilde{A}_{11} & 0 \\ 0 & A_{22} \end{bmatrix} \begin{bmatrix} \tilde{X}_{11} & \tilde{X}_{12} \\ \tilde{X}_{12}^T & \tilde{X}_{22} \end{bmatrix} + \begin{bmatrix} \tilde{X}_{11} & \tilde{X}_{12} \\ \tilde{X}_{12}^T & \tilde{X}_{22} \end{bmatrix} \begin{bmatrix} \tilde{A}_{11}^T & 0 \\ 0 & A_{22}^T \end{bmatrix} = -\hat{G}\hat{G}^T, \quad (4.11)$$

where

$$\begin{aligned} \tilde{A} &= \begin{bmatrix} \tilde{A}_{11} & 0 \\ 0 & A_{22} \end{bmatrix}, \quad \tilde{X} = \begin{bmatrix} \tilde{X}_{11} & \tilde{X}_{12} \\ \tilde{X}_{12}^T & \tilde{X}_{22} \end{bmatrix}, \\ \tilde{A}_{11} &= \hat{A}_{p(1)} \oplus \hat{A}_{p(2)} \oplus \dots \oplus \hat{A}_{p(s)}, \quad \hat{A}_i = \begin{bmatrix} 0 & \omega_i \\ -\omega_i & -\alpha\omega_i \end{bmatrix}. \end{aligned} \quad (4.12)$$

Note that $\tilde{X}_{12} = 0$, $\tilde{X}_{22} = 0$ and \tilde{X}_{11} is the solution of the equation

$$A_{11}\tilde{X}_{11} + \tilde{X}_{11}A_{11}^T = -\tilde{G}\tilde{G}^T,$$

where $\tilde{G} = \hat{G}(1 : 2r, 1 : 2s)$. Since $\tilde{G}\tilde{G}^T = I$, it is easy to observe that

$$\tilde{X}_{11} = \hat{X}_1 \oplus \hat{X}_2 \oplus \dots \oplus \hat{X}_s, \quad \text{where} \quad \hat{X}_i = \frac{1}{\omega_i} \begin{bmatrix} \frac{2+\alpha^2}{2\alpha} & -\frac{1}{2} \\ -\frac{1}{2} & \frac{1}{\alpha} \end{bmatrix}, \quad (4.13)$$

and that $\text{trace} \tilde{X} = \text{trace} \tilde{X}_{11} = \tau_0$.

Similarly to Section 3.2, we can now derive the error bound for the approximation (4.11). Using that $\text{trace } \tilde{X}_{11} = \tau_0$ and $C = \Phi^T C_{ext} \Phi = \Phi^T (v_1 C_1 + v_2 C_2 + \cdots + v_k C_k) \Phi$ we have that

$$\frac{|\text{trace}(X(C)) - \tau_0|}{\tau_0} \leq \max_{\substack{i=1,\dots,s \\ j=1,\dots,n}} |v_1 C_1^\Phi(p(i), j) + \cdots + v_k C_k^\Phi(p(i), j)| \cdot \xi \quad (4.14)$$

with

$$\xi = \frac{\left(\text{trace}(|\Lambda_{11}|^T |\tilde{G}\tilde{G}^T|) + \sum_{i,j=1}^{2s} |\tilde{a}_{ji}| |(\Lambda_{11} \tilde{X}_{11})_{ij}| + \sum_{i,j=1}^{2s} |\tilde{a}_{ji}| |(\Lambda_{11} \tilde{X}_{11})_{ji}| \right)}{\tau_0},$$

where $(\tilde{A}_{11})_{ij} = \tilde{a}_{ij}$, $C_i^\Phi = \Phi^T C_i \Phi$, for $i = 1, \dots, k$ and \tilde{A}_{11} , \tilde{X}_{11} are given in Equations (4.12) and (4.13), respectively. Recall that $|\tilde{G}\tilde{G}^T| = I$ and that Λ_{11} is the solution of the Lyapunov equation $\tilde{A}_{11}^T \Lambda_{11} + \Lambda_{11} \tilde{A}_{11} = I$, thus we have that $\Lambda_{11} = -\tilde{X}_{11}$ and it holds that

$$\xi = \left(1 + 2 \frac{\sum_{i,j=1}^{2s} |\tilde{a}_{ji}| |(\tilde{X}_{11}^2)_{ij}|}{\tau_0} \right), \quad (4.15)$$

where τ_0 is given in (4.10).

In order to obtain an easily computable bound for given external damping C_{ext} , we need to fix feasible maximal values of the dampers' viscosities. Such an upper bound is also usually needed in the viscosity optimization algorithm. Let the maximal viscosity v_i be v_i^{max} , $i = 1, \dots, k$, respectively. Using this to bound right-hand side in (4.14), we obtain

$$\frac{|\text{trace}(X(C)) - \tau_0|}{\tau_0} \leq \max_{\substack{i=1,\dots,s \\ j=1,\dots,n}} v_1^{max} |C_1^\Phi(p(i), j)| + \cdots + v_k^{max} |C_k^\Phi(p(i), j)| \cdot \xi \quad (4.16)$$

where ξ is given in Equation (4.15).

Note that in the case of dampers' positions with the same viscosity $v^{max} := v_1 = \dots = v_k$, we can bound the right-hand side of (4.14), such that it yields

$$\max_{\substack{i=1,\dots,s \\ j=1,\dots,n}} v^{max} |C_1^\Phi(p(i), j) + \dots + C_k^\Phi(p(i), j)| \cdot \xi, \quad (4.17)$$

where v^{max} is a feasible maximal value of the dampers' viscosities.

For dampers' positions, such that the right-hand side of bound (4.16) is small enough (smaller than some tolerance), we can conclude that these dampers' positions have a negligible influence on damping of the system. Thus, in the resulting algorithm we mark these dampers' positions as the positions that do not damp the system. With such approach we can efficiently determine positions that do not damp the system. The tolerance employed here should be of the order of the relative termination tolerance used for the viscosity optimization.

An algorithm for computing the area which contains the optimal dampers' positions is summarized in Algorithm 4.5.1.

Remark 4.5.1. *Algorithm 4.5.1 will be efficient if the system has some special structure, more precisely, when there are numerous positions such that the maximum term in the bound (4.16) is small enough. That can also be checked in advance by analyzing the magnitude of the elements of the matrix C . Particularly, if there exist numerous indices i such that $\|\Phi(i, p)\|$ (p corresponds to indices of the undamped eigenfrequencies that have to be damped) is small, then our algorithm will determine numerous positions that cannot be used to damp the system. Our experiments have shown that, for example, if we like to damp eigenfrequencies that are large by magnitude, for mechanical systems with equal stiffnesses and increasing masses, we will have that $\|\Phi(i, p)\|$ will be small for a large number of pairs (i, p) .*

Note that in the **while**-loop of Algorithm 4.5.1 all dampers' positions should be checked. Generally this means that we should check all configurations $(i_1, i_2, \dots, i_k) \in \mathbb{N}^k$ such that $1 \leq i_1 < i_2 < \dots < i_k \leq n$.

Algorithm 4.5.1 (Determination of possible optimal dampers' positions)

Input: Φ – such that $\Phi^T K \Phi = \Omega^2 = \text{diag}(\omega_1^2, \dots, \omega_n^2)$ and $\Phi^T M \Phi = I$;
 $p(1), p(2), \dots, p(s)$ – indices of eigenfrequencies which have to be damped;
 v_i^{max} , $i = 1, \dots, k$ – maximal viscosities;
 tol_{pos} .

Output: Set \mathcal{S} of positions that contains the optimal dampers' positions.

- 1: Calculate $\xi = \left(1 + 2 \frac{\sum_{i,j=1}^{2s} |\tilde{a}_{ji}| |(\tilde{X}_{I_1}^2)_{ij}|}{\tau_0}\right)$ from (4.15).
- 2: **while** not all configurations of the dampers' position have been checked
do
- 3: For given dampers' positions, calculate

$$\varepsilon = \max_{\substack{i=1,\dots,s \\ j=1,\dots,n}} v_1^{max} |C_1^\Phi(p(i), j)| + \dots + v_k^{max} |C_k^\Phi(p(i), j)| \xi.$$

- 4: **if** $\varepsilon < tol_{pos}$ **then**
- 5: Exclude the corresponding configuration from \mathcal{S} .
- 6: **end if**
- 7: **end while**

For structured systems, Algorithm 4.5.1 is quite efficient since the main calculation cost for different positions is the calculation of the corresponding maximum in Step 3.

4.5.1 Numerical experiments

We will present examples that illustrate efficiency of Algorithm 4.5.1 for determination of the area with the optimal dampers' positions.

The first example considers a structured system with two dampers of different viscosities.

Example 4.6. *In this example we consider the mechanical system shown in Figure 4.5 with two dampers of different viscosities, $2d + 1$ masses and $2d + 3$ springs.*

In the considered vibrational system the mass matrix is $M = \text{diag}(m_1, m_2, \dots, m_n)$, while the stiffness matrix is defined as:

$$K = \begin{bmatrix} K_{11} & & -\kappa_1 \\ & K_{11} & -\kappa_1 \\ -\kappa_1^T & -\kappa_1^T & 2k_1 + k_2 \end{bmatrix},$$

where

$$K_{11} = k_1 \begin{bmatrix} 2 & -1 & & & \\ -1 & 2 & -1 & & \\ & \ddots & \ddots & \ddots & \\ & & -1 & 2 & -1 \\ & & & -1 & 2 \end{bmatrix}, \quad \kappa_1 = \begin{bmatrix} 0 \\ \vdots \\ 0 \\ k_1 \end{bmatrix}.$$

In our example we will consider the following configuration:

$$\begin{aligned} d &= 500, \quad n = 2d + 1 = 1001; \quad k_1 = 10, \quad k_2 = 20; \\ m_i &= 10 \cdot i \quad \text{for } i = 1, \dots, d/5; \\ m_i &= (12/5) \cdot d + 2 - 2i \quad \text{for } i = d/5 + 1, \dots, d; \\ m_i &= 5 \cdot (2d + 1 - i) \quad \text{for } i = d + 1, \dots, 2d; \quad m_{2d+1} = 500. \end{aligned}$$

A damping matrix is $D = C_u + C_{ext}$, where the internal damping matrix C_u is defined as in (1.3) and external damping is defined by $C_{ext} = v_1 e_i e_i^T + v_2 e_j e_j^T$, where $1 \leq i < j \leq n$.

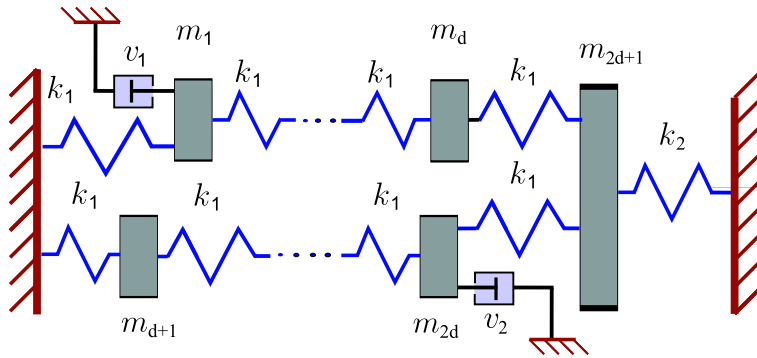

Figure 4.5: $2d + 1$ mass oscillator

In this example we would like to damp all eigenfrequencies of the undamped system, by magnitude larger than 1. This gives that $s = 6$.

We have used the following configuration in Algorithm 4.5.1, with undamped eigenfrequencies sorted such that $\omega_1 > \omega_2 > \dots > \omega_n$:

$$\begin{aligned}\alpha_c &= 0.001; \\ p(i) &= i, \quad i = 1, \dots, s; \\ tol_{pos} &= 10^{-8}; \\ v_1^{max} &= v_2^{max} = 1000.\end{aligned}$$

Recall that in this example we consider two dampers of different viscosities; this means that we want to determine the optimal positions i and j such that $1 \leq i < j \leq n$. This offers $n(n-1)/2$ different dampers' positions and for this example this means that we have 500 500 different configurations. Using Algorithm 4.5.1 with the tolerance $tol_{pos} = 10^{-8}$ we have obtained that 473 851 of them are not useful for damping the system. That is, a set of configurations which contains the optimal position has 26 649 elements. Thus, with Algorithm 4.5.1 we have reduced the number of different dampers' positions to just 5.32% of the total number of the possible positions. More precisely, Algorithm 4.5.1 returned that a set that contains the optimal dampers position (i_{opt}, j_{opt}) is equal to the set $\mathcal{S} = \mathcal{S}_1 \cup \mathcal{S}_2 \cup \mathcal{S}_3 \cup \mathcal{S}_4$, where

$$\begin{aligned}\mathcal{S}_1 &= \{(i, j) : \text{for } i \leq 9; \ j \text{ is such that } i + 1 \leq j\}, \\ \mathcal{S}_2 &= \{(i, j) : \text{for } i = 499, 500; \ j \text{ is such that } i + 1 \leq j\}, \\ \mathcal{S}_3 &= \{(i, j) : \text{for } j = 499, 500; \ i \text{ is such that } i \leq j - 1\}, \\ \mathcal{S}_4 &= \{(i, j) : \text{for } 986 \leq j \leq 1001; \ i \text{ is such that } i \leq j - 1\}.\end{aligned}$$

In order to test our algorithm we have calculated the minimal trace for the position on the following mesh of the dampers' positions:

$$i = 4 : 165 : n, \quad j = i + 1 : 165 : n.$$

A mesh is constructed such that different positions from \mathcal{S} are included but also some positions which are not in \mathcal{S} .

For this mesh, the optimal position $(i_{opt}, j_{opt}) = (4, 995)$, the optimal viscosities at these positions are $(v_1, v_2) = (23.91853, 14.78638)$ and the corresponding trace is 1839.11344. In this example the trace of the solution of the Lyapunov equation that corresponds to the undamped system is $\tau_0 = 4559.12291$. On the other hand, it is easy to check that for the positions that are not in \mathcal{S} , for example, for positions (169, 170), (334, 665) and (664, 830) the minimal trace is equal to the trace τ_0 up to $O(tol_{pos})$.

Example 4.7. *In this example we consider an n -mass oscillator with n masses and $n+1$ springs with two dampers of the same viscosity (shown in Figure 1.2).*

In the considered vibrational system the mass matrix is a diagonal matrix $M = \text{diag}(m_1, m_2, \dots, m_n)$, while the stiffness matrix is defined in (1.7), where $k_i > 0$ represents stiffness of the corresponding spring.

In this example we will consider the following configuration:

$$\begin{aligned} n &= 1000, & k_i &= 4 \quad \text{for } i = 1, \dots, n+1; \\ m_i &= 300 \cdot (301 - i) \quad \text{for } i = 1, \dots, 300; \\ m_i &= i \quad \text{for } i = 301, \dots, 400; \\ m_i &= i \cdot (i - 400) \quad \text{for } i = 401, \dots, n. \end{aligned}$$

Recall that the damping matrix is $D = C_u + C_{ext}$, where the internal damping matrix C_u is defined as in (1.3). Since we have two dampers of the same viscosity v , external damping is defined by $C_{ext} = v(e_i e_i^T + e_j e_j^T)$, where $1 \leq i < j \leq n$.

In this example we would like to damp all undamped eigenfrequencies ω_i such that $0.05 \leq \omega_i \leq 0.1$. If we sort undamped eigenfrequencies such that $\omega_1 > \omega_2 > \dots > \omega_n$, then we have to damp ω_i for $i = 899, \dots, 928$ (this yields $s = 29$).

We have used the following configuration in Algorithm 4.5.1:

$$\begin{aligned}\alpha_c &= 0.001; \\ p(i) &= 73 + i, \quad i = 1, \dots, s; \\ tol_{pos} &= 10^{-8}; \\ v^{max} &= 1000.\end{aligned}$$

Since we have two dampers with the same viscosities, in Algorithm 4.5.1 in Step 3, we will use bound (4.17).

We consider two dampers of the same viscosities. This means that we want to determine positions i and j such that $1 \leq i < j \leq n$. This gives that we have $n(n-1)/2 = 499\,500$ different configurations. Similarly to the previous example, here using Algorithm 4.5.1 with tolerance $tol_{pos} = 10^{-8}$ we have obtained that 361 674 of them do not damp the system. That is, with Algorithm 4.5.1 we have reduced the number of different dampers' positions to 27.59% of the total number of dampers' positions. Algorithm 4.5.1 returned that the set containing the optimal dampers' position (i_{opt}, j_{opt}) is equal to the set $\mathcal{S} = \mathcal{S}_1 \cup \mathcal{S}_2$, where

$$\begin{aligned}\mathcal{S}_1 &= \{(i, j) : \text{for } 273 \leq i \leq 421; \ j \text{ is such that } i + 1 \leq j\}, \\ \mathcal{S}_2 &= \{(i, j) : \text{for } 273 \leq j \leq 421; \ i \text{ is such that } i \leq j - 1\}.\end{aligned}$$

In order to test our algorithm we have calculated a minimal trace for the position on the following mesh of the dampers' positions:

$$i = 1 : 24 : n, \quad j = i + 1 : 24 : n.$$

At the above mesh, the optimal position $(i_{opt}, j_{opt}) = (337, 386)$ (optimal viscosities at these positions are $v_{opt} = 60.93162$ with the corresponding trace equal to 82 960.30789). The trace of the solution of the Lyapunov equation

that corresponds to the undamped system is $\tau_0 = 421\,683.30082$. Furthermore, it is easy to check that for the positions that are not in \mathcal{S} , a minimal trace is equal to the trace τ_0 up to $O(tol_{pos})$.

Observe that in the above two examples we have reduced the total number of positions to positions given in \mathcal{S} (using tolerance $tol_{pos} = 10^{-8}$). This means that for determination of the optimal position we should search positions contained in the set \mathcal{S} . Thus we need to optimize viscosities on some mesh of the positions contained in the set \mathcal{S} . For this optimization process we should again use Algorithm 3.3.1 (now, with the tolerance greater than tol_{pos}) which will additionally accelerate the optimization process.

4.6 Conclusions

This chapter is devoted to the efficient determination of optimal damping focused on the optimization of dampers' positions. In some cases, such as for one-dimensional damping, this problem could be solved with the "Direct" approach using a formula for optimal viscosity.

Furthermore, the optimization could be accelerated for structured problems, where we have given an algorithm that determines the area containing the optimal dampers' positions.

For the general case we have presented two heuristics (the "Multigrid-like" and the "Discrete to continuous" approach) that drastically accelerate the optimization process. Additionally, we have also presented an algorithm that combines heuristical approaches with dimension reduction technique that makes the optimization for moderate or large dimensions possible. Numerical experiments show good performance of new approaches.

Chapter 5

Optimal damping of a system - a case study

Constructing the efficient algorithm for determination of optimal damping has been proved rather hard, except for rank one-dimensional damping described in Section 4.1.1 (more details can be found in [57; 14]).

Recall that we consider a damped linear vibrational system

$$M\ddot{x} + D\dot{x} + Kx = 0.$$

Contrary to the internal damping C_u which was used in previous chapters, here we assume that internal damping is equal to zero, that is, damping matrix $D = C_{ext}$.

First, we will state the result for the rank one-dimensional damping in more details. Recall that in the case of rank one-dimensional damping we have that damping matrix $D = vcc^T$, where $c \in \mathbb{R}^n$. If we consider the case where we damp all undamped eigenfrequencies, then the corresponding Lyapunov equation is

$$A^T X(v) + X(v)A = -I, \tag{5.1}$$

for the matrix A it holds

$$A = \begin{pmatrix} 0 & \Omega \\ -\Omega & -vcc^T \end{pmatrix},$$

where $v > 0$, $c = (c_1 c_2 \cdots c_n)^T$, $c_i \neq 0 \quad i = 1, \dots, n$. The matrix Ω is a diagonal matrix that contains undamped eigenfrequencies on its diagonal, that is $\Omega = \text{diag}(\omega_1, \dots, \omega_n)$, where $0 < \omega_1 < \omega_2 < \dots < \omega_n$. The trace of the solution of the Lyapunov equation (5.1) can be calculated by a simple formula. That is, using [14, Lema 4.3] we will obtain that the trace formula is just

$$\begin{aligned} \text{trace } X(v) &= \frac{1}{v} \sum_{i=1}^n \frac{2}{c_i^2} + v \sum_{i=1}^n \sum_{\substack{j=1 \\ j \neq i}}^n \frac{3\omega_i^2 c_j^2 + c_i^2 \omega_i^2}{(\omega_i^2 - \omega_j^2)^2} + v \sum_{i=1}^n \frac{2\omega_i^2}{c_i^2} \left(\sum_{\substack{k=1 \\ k \neq i}}^n \frac{c_k^2}{\omega_k^2 - \omega_i^2} \right)^2 \\ &+ v \sum_{i=1}^n \frac{c_i^2}{2\omega_i^2} + v \sum_{i=1}^n \sum_{\substack{j=1 \\ j \neq i}}^n \frac{\omega_j^2 (c_j^2 + c_i^2)}{(\omega_i^2 - \omega_j^2)^2}. \end{aligned}$$

Here v is viscosity which has to be optimized and $X(v)$ is the corresponding solution of the Lyapunov equation. Using this formula we can obtain a simple formula for the optimal viscosity. Recall that we have used this formula in Subsection 4.1.1.

The analogous formula for C_{ext} of rank 2 obtained in this chapter is much more complicated; it consists of the explicit formulae, similar to those in [57] but here we have to solve an additional linear system of order $\frac{n}{2}$. Properties of this system and the condition number are not easy to discover but the required number of flops for calculation of the solution using the new formula is equal to $4.6n^3 + \mathcal{O}(n^2)$ flops. This is considerably less than using the standard Bartels-Stewart algorithm which requires around $30n^3$. This means that by using a new approach we can significantly accelerate our optimization process.

The main aim of this chapter is to present a similar solution in a very special case. We will consider a damped linear vibrational system with multiple

undamped eigenfrequencies. That is, we assume that the undamped eigenfrequencies are double in pairs: $\omega_1 = \omega_2, \omega_3 = \omega_4, \dots$ or they consist of close clusters $\omega_1 \approx \omega_2, \omega_3 \approx \omega_4, \dots$. Recall that positive numbers $\omega_1, \omega_2, \dots, \omega_n$ are eigenvalues of the undamped system $M\ddot{x} + Kx = 0$, and they are diagonal elements of matrix Ω .

Multiple eigenfrequencies are a well studied problem, for example see [35]. They appear among others in the model which describes vibration of a membrane (membrane eigenfrequencies are given explicitly in [30]).

We also assume that the damping matrix has rank 2, that is

$$C_{ext} = vcc^T, \quad c = \begin{pmatrix} c_1 \\ c_2 \\ \vdots \\ c_s \end{pmatrix}, \quad c_i = \begin{pmatrix} c_{11}^i & c_{12}^i \\ c_{21}^i & c_{22}^i \end{pmatrix} \in \mathbb{R}^{2 \times 2},$$

where v stands here for viscosity. This appears to be the closest generalization of the solution presented in [57].

Since our main problem is determination of a solution of a strongly structured system, we will consider the so-called dual Lyapunov equation introduced in Section 1.2, that is, we will consider the Lyapunov equation

$$A^T \widehat{X} + \widehat{X} A = -I, \quad (5.2)$$

where

$$A = \begin{pmatrix} 0 & \Omega \\ -\Omega & 0 \end{pmatrix} - v \begin{pmatrix} 0 & 0 \\ 0 & cc^T \end{pmatrix} = \begin{pmatrix} 0 & \Omega \\ -\Omega & -vcc^T \end{pmatrix}, \quad (5.3)$$

is a $m \times m$ real matrix ($m = 2n$) and $v \in \mathbb{R}_+$ represents viscosity. Since undamped eigenfrequencies are double in pairs, we have the following structure for the matrix Ω :

$$\Omega = \text{diag}(\Omega_1, \Omega_2, \dots, \Omega_s), \quad s = \frac{m}{4} \left(= \frac{n}{2} \right), \quad (5.4)$$

$$\Omega_i = \omega_i \begin{pmatrix} 1 & 0 \\ 0 & 1 \end{pmatrix}, \quad c = \begin{pmatrix} c_1 \\ c_2 \\ \vdots \\ c_s \end{pmatrix}, \quad c_i = \begin{pmatrix} c_{11}^i & c_{12}^i \\ c_{21}^i & c_{22}^i \end{pmatrix} \in \mathbb{R}^{2 \times 2},$$

and each c_i is non-singular and $\omega_i \neq \omega_j$ for $i \neq j$. This non-singularity means that the form $x^T C_{ext} x$ is positive definite on any eigenspace of the undamped system, which is necessary for the system to be asymptotically stable at all.

Recall that the optimization criterion in this case is given by (see criterion (1.19))

$$\text{trace } \widehat{X} Z \rightarrow \min, \quad (5.5)$$

where Z determines which part of the undamped eigenfrequencies has to be damped. We will consider the case when we damp all undamped eigenfrequencies which means that $Z = I$.

Remark 5.0.1. *An assumption on asymptotic stability implies the uniqueness of the solution of the Lyapunov equation (5.2). On the other hand, it can be shown that if c_i has rank one for some i , then A from Equation (5.2) has some eigenvalues on an imaginary axis.*

5.1 Solution of a structured Lyapunov equation

Our aim in this section is to derive the solution of Lyapunov equation (5.2), then we will be able to calculate easily its trace as well.

The solution X can be represented in the block form

$$\widehat{X} = \begin{pmatrix} X_{11} & X_{12} \\ X_{12}^T & X_{22} \end{pmatrix}. \quad (5.6)$$

For the sake of simplicity, we will introduce d where

$$d = \sqrt{v} c, \quad (5.7)$$

then we can write

$$vc c^T = dd^T, \quad d = \begin{pmatrix} d_1^T & \dots & d_s^T \end{pmatrix}^T,$$

where d_i is a corresponding 2×2 matrix for all $i, i = 1, 2, \dots, s$.

Using the above notation, Equation (5.2) can be written as

$$\begin{pmatrix} 0 & -\Omega \\ \Omega & -dd^T \end{pmatrix} \begin{pmatrix} X_{11} & X_{12} \\ X_{12}^T & X_{22} \end{pmatrix} + \begin{pmatrix} X_{11} & X_{12} \\ X_{12}^T & X_{22} \end{pmatrix} \begin{pmatrix} 0 & \Omega \\ -\Omega & -dd^T \end{pmatrix} = \begin{pmatrix} -I & 0 \\ 0 & -I \end{pmatrix}. \quad (5.8)$$

By equalizing the corresponding blocks we obtain

$$\Omega X_{12}^T + X_{12} \Omega = I, \quad (5.9)$$

$$-\Omega X_{22} + X_{11} \Omega - X_{12} dd^T = 0, \quad (5.10)$$

$$\Omega X_{11} - dd^T X_{12}^T - X_{22} \Omega = 0, \quad (5.11)$$

$$\Omega X_{12} - dd^T X_{22} + X_{12}^T \Omega - X_{22} dd^T = -I. \quad (5.12)$$

With direct substitution we can check that solution X_{12} of Equation (5.9) has the following form

$$X_{12} = \frac{1}{2} \Omega^{-1} + \frac{1}{2} S \Omega^{-1}, \quad (5.13)$$

where S is a skew-symmetric matrix to be determined. Because of the uniqueness of the matrix X we have uniqueness of matrix X_{12} and matrix S .

Diagonal 2×2 blocks from Equation (5.9) satisfy

$$(\Omega X_{12} + X_{12}^T \Omega)_{ii} = I_{ii}. \quad (5.14)$$

Using Equation (5.14), 2×2 diagonal blocks from Equation (5.12) have the following form:

$$d_i \mathbb{X}_i + \mathbb{X}_i^T d_i^T = 2I, \quad (5.15)$$

where

$$\mathbb{X} \equiv [\mathbb{X}_1, \dots, \mathbb{X}_s] = d^T X_{22}, \quad \mathbb{X}_i \in \mathbb{R}^{2 \times 2}. \quad (5.16)$$

Equation (5.15) implies

$$\mathbb{X}_i = d_i^{-1} + \sigma_i d_i^{-1} J, \quad (5.17)$$

where $J = \begin{pmatrix} 0 & 1 \\ -1 & 0 \end{pmatrix}$ and $\sigma_i \in \mathbb{R}$, $i = 1, 2, \dots, s$ are unknowns which have to be found.

Note that the only unknown quantities in the above equations are σ_i . Thus our aim is to construct an $s \times s$ linear system with solution σ_i , $i = 1, 2, \dots, s$. For that purpose we will derive some auxiliary results.

Using equations (5.13) and (5.16), Equation (5.12) can be written as

$$\Omega S \Omega^{-1} - \Omega^{-1} S \Omega = 2(d\mathbb{X} + \mathbb{X}^T d^T) - 4I. \quad (5.18)$$

Set $S = (s_{ij})$ where s_{ij} are 2×2 matrices. By equalizing the corresponding off diagonal blocks, from Equation (5.18), for non-diagonal blocks s_{ij} we have

$$s_{ij} = \frac{2\omega_i \omega_j}{\omega_i^2 - \omega_j^2} (d_i d_j^{-1} + d_i^{-T} d_j^T + \sigma_j d_i d_j^{-1} J - \sigma_i J d_i^{-T} d_j^T), \quad i \neq j. \quad (5.19)$$

As we have already mentioned above, uniqueness of the solution X implies uniqueness of skew-symmetric matrix S . Now from Equation (5.19) follows uniqueness of unknowns $\sigma_1, \dots, \sigma_s$.

Further, let $T = X_{12}dd^T$ be the matrix whose (i, j) -th 2×2 block is denoted by t_{ij} . Using Equation (5.13) we obtain

$$\begin{aligned} t_{ij} &= (X_{12}dd^T)_{ij} \\ &= \frac{1}{2}[(\Omega^{-1} + S\Omega^{-1})d]_i d_j^T \\ &= \frac{1}{2\omega_i} d_i d_j^T + \sum_{k \neq i}^s s_{ik} \frac{d_k d_j^T}{2\omega_k} + s_{ii} \frac{d_i d_j^T}{2\omega_i}. \end{aligned} \quad (5.20)$$

Thus, if we express s_{ii} as a function of s_{ij} with $i \neq j$, then t_{ij} from Equation (5.20) will be defined with known parts and σ_i .

Now we continue with deriving the expression for s_{ii} as a function of s_{ij} , for $i \neq j$. We introduce the following notation

$$(X_{11})_{ij} = \eta_{ij}, \text{ and } (X_{22})_{ij} = \xi_{ij}, \quad (5.21)$$

where η_{ij} and ξ_{ij} denote 2×2 matrices. Now, considering the (i, j) -th 2×2 block ($i \neq j$), of equations (5.10) and (5.11) for η_{ij} and ξ_{ij} we have

$$\eta_{ij} = \frac{\omega_j t_{ij} - t_{ji}^T \omega_i}{\omega_j^2 - \omega_i^2}, \quad (5.22)$$

$$\xi_{ij} = \frac{\omega_i t_{ij} - t_{ji}^T \omega_j}{\omega_j^2 - \omega_i^2}. \quad (5.23)$$

Further, the (i, i) -th block from Equation (5.10) can be written as

$$t_{ii} = -\omega_i \xi_{ii} + \omega_i \eta_{ii}. \quad (5.24)$$

From the symmetry of X_{11} and X_{22} (which are diagonal blocks of symmetric matrix \widehat{X}) and (5.24), it follows that $t_{ii} = t_{ii}^T$. Using this and (5.20) it follows

$$\frac{d_i d_i^T}{2\omega_i} + \sum_{j=1}^s s_{ij} \frac{d_j d_i^T}{2\omega_j} = \frac{d_i d_i^T}{2\omega_i} + \sum_{j=1}^s \frac{d_i d_j^T}{2\omega_j} s_{ij}^T. \quad (5.25)$$

Recall that S is a skew-symmetric matrix which implies $s_{ij} = -s_{ji}^T$, using this from Equation (5.25) for s_{ii} we have the following equality

$$s_{ii} = \sum_{j \neq i}^s \left(-s_{ij} \frac{d_j d_i^T}{\omega_j} - \frac{d_i d_j^T}{\omega_j} s_{ji} \right) D_i J, \quad \text{where} \quad (5.26)$$

$$D_i = (J d_i d_i^T + d_i d_i^T J)^{-1} = \begin{pmatrix} 0 & -\frac{1}{\|d_i\|_F^2} \\ \frac{1}{\|d_i\|_F^2} & 0 \end{pmatrix}$$

and no denominator vanishes.

Note that, using equations (5.26) and (5.19), t_{ij} from Equation (5.20) can be expressed as a function of known quantities and σ_i , $i = 1, \dots, s$. Thus, after some manipulations we have

$$\begin{aligned} t_{ij} &= \sum_{k \neq i}^s \frac{\omega_i}{\omega_i^2 - \omega_k^2} [d_i d_j^T + d_i^{-T} d_k^T d_k d_j^T - (d_i^{-T} d_k^T d_k d_i^T - d_i d_k^T d_k d_i^{-1}) D_i J d_i d_j^T] + \\ &+ \frac{d_i d_j^T}{2\omega_i} + \sum_{k \neq i}^s \frac{\omega_i}{\omega_i^2 - \omega_k^2} (\sigma_k d_i d_k^{-1} J - \sigma_i J d_i^{-T} d_k^T) d_k d_j^T - \\ &- \sum_{k \neq i}^s \frac{\omega_i}{\omega_i^2 - \omega_k^2} [\sigma_k d_i (d_k^{-1} J d_k + d_k^T J d_k^{-T}) d_i^T - \sigma_i (J d_i^{-T} d_k^T d_k d_i^T + d_i d_k^T d_k d_i^{-1} J)] \times \\ &\times D_i J d_i d_j^T. \end{aligned} \quad (5.27)$$

We set

$$\begin{aligned} \tau_{ij}^0 &= \frac{d_i d_j^T}{2\omega_i} + \\ &+ \sum_{k \neq i}^s \frac{\omega_i}{\omega_i^2 - \omega_k^2} [d_i d_j^T + d_i^{-T} d_k^T d_k d_j^T - (d_i^{-T} d_k^T d_k d_i^T - d_i d_k^T d_k d_i^{-1}) D_i J d_i d_j^T], \end{aligned}$$

(note that τ_{ij}^0 is given by known quantities). Then

$$\tau_{ij}^1(\sigma_1, \dots, \sigma_s) \equiv \tau_{ij}^1 = t_{ij} - \tau_{ij}^0, \quad (5.28)$$

depends on known quantities and σ_i , $i = 1, \dots, s$.

Remark 5.1.1. Here we would like to emphasize that non-singularity of c_i ($d_i = \sqrt{vc_i}$) implies uniqueness of $\sigma_1, \dots, \sigma_s$ which further implies uniqueness of t_{ij} from Equation (5.27), then from equations (5.22) and (5.23) we have uniqueness of X_{11} and X_{22} , all this together with Equation (5.13) implies uniqueness of the solution X .

We continue the construction of the linear system with unknowns $\sigma_i, i = 1, \dots, s$. From Equation (5.17) it follows

$$\mathbb{X}_i = d_i^{-1} + \sigma_i d_i^{-1} J = (d^T X_{22})_i = \sum_{j=1}^s d_j^T \xi_{ji},$$

which gives

$$\xi_{ii} = d_i^{-T} d_i^{-1} + \sigma_i d_i^{-T} d_i^{-1} J - \sum_{j \neq i} d_i^{-T} d_j^T \xi_{ji}. \quad (5.29)$$

Using the fact that $\xi_{ji}^T = \xi_{ij}$ from Equation (5.29) we have

$$\sigma_i E_i = \sum_{j \neq i} d_i^{-T} d_j^T \xi_{ji} - \xi_{ij} d_j d_i^{-1}, \quad i = 1, \dots, s, \quad (5.30)$$

where

$$E_i \equiv d_i^{-T} d_i^{-1} J + J d_i^{-T} d_i^{-1} = \frac{1}{\det(d_i)} \begin{pmatrix} 0 & \|d_i\|_F^2 \\ -\|d_i\|_F^2 & 0 \end{pmatrix}.$$

From equations (5.23) and (5.27) it follows that Equation (5.30) determines a system of equations with unknowns $\sigma_1, \dots, \sigma_s$. We will continue with reformulation of Equation (5.30) in a much more appropriate form for numerical computation.

Let

$$R_i = \sum_{j \neq i} d_i^{-T} d_j^T \xi_{ji} - \xi_{ij} d_j d_i^{-1}, \quad i = 1, \dots, s, \quad (5.31)$$

be the right-hand side of Equation (5.30). Let R_i^0 be the part of R_i which does not depend on σ_i , and let R_i^1 be the part of R_i which depends on σ_i . This

means that, using Equations (5.23) and (5.28), R_i can be written as

$$R_i = R_i^0 - (R_i^0)^T + R_i^1 - (R_i^1)^T, \quad (5.32)$$

where

$$R_i^0 = \sum_{j \neq i} d_i^{-T} d_j^T \frac{\omega_j \tau_{ji}^0 - (\tau_{ij}^0)^T \omega_i}{\omega_i^2 - \omega_j^2}, \quad R_i^1 = \sum_{j \neq i} d_i^{-T} d_j^T \frac{\omega_j \tau_{ji}^1 - (\tau_{ij}^1)^T \omega_i}{\omega_i^2 - \omega_j^2}. \quad (5.33)$$

Recall, that from Equations (5.27) and (5.28) it follows that

$$\begin{aligned} \tau_{ij}^1 &= \sum_{k \neq i} \frac{\omega_i}{\omega_i^2 - \omega_k^2} (\sigma_k d_i d_k^{-1} J - \sigma_i J d_i^{-T} d_k^T) d_k d_j^T \\ &\quad - \sum_{k \neq i} \frac{\omega_i}{\omega_i^2 - \omega_k^2} [\sigma_k d_i (d_k^{-1} J d_k + d_k^T J d_k^{-T}) d_i^T - \sigma_i (J d_i^{-T} d_k^T d_k d_i^T + d_i d_k^T d_k d_i^{-1} J)] \times \\ &\quad \times D_i J d_i d_j^T. \end{aligned}$$

Inserting the above expression for τ_{ij}^1 in R_i^1 from Equation (5.33) after long and tedious calculations we obtain

$$R_i^1 = \sum_{k \neq i} \sigma_k \left(\sum_{j \neq k, i} A_{jk}^i + \sum_{j \neq k} B_{jk}^i + \sum_{j \neq i} (C_{ext})_{kj}^i \right) + \sigma_i \left(\sum_{j \neq i} A_{ji}^i - S_i \right), \quad (5.34)$$

where

$$A_{jk}^i = \frac{\omega_j^2 d_i^{-T} d_j^T d_j [d_k^{-1} J d_k - (d_k^{-1} J d_k + d_k^T J d_k^{-T}) d_j^T D_j J d_j] d_i^T}{(\omega_j^2 - \omega_k^2)(\omega_i^2 - \omega_j^2)}, \quad (5.35)$$

$$B_{jk}^i = \frac{\omega_k^2 d_i^{-T} d_k^T [-J d_k^{-T} d_j^T d_j + (J d_k^{-T} d_j^T d_j d_k^T + d_k d_j^T d_j d_k^{-1} J) D_k J d_k] d_i^T}{(\omega_k^2 - \omega_j^2)(\omega_i^2 - \omega_k^2)}, \quad (5.36)$$

$$(C_{ext})_{kj}^i = \frac{\omega_i^2 d_i^{-T} d_j^T d_j [d_k^T J d_k^{-T} + d_i^T J D_i^T d_i (d_k^T J d_k^{-T} + d_k^{-1} J d_k)] d_i^T}{(\omega_i^2 - \omega_k^2)(\omega_i^2 - \omega_j^2)}, \quad (5.37)$$

$$S_i = \sum_{k \neq i} \sum_{j \neq i} \frac{\omega_i^2 d_i^{-T} d_j^T d_j [d_k^T d_k d_i^{-1} J + d_i^T J D_i^T (d_i d_k^T d_k d_i^{-1} J + J d_i^{-T} d_k^T d_k d_i^T)]}{(\omega_i^2 - \omega_k^2)(\omega_i^2 - \omega_j^2)}. \quad (5.38)$$

After inserting R_i^1 into Equation (5.30) we obtain the following linear system

$$\mathbb{A} \mathbb{Y} = \mathbb{B}, \quad (5.39)$$

where $\mathbb{A} = (\mathbb{A}_{ki}) \in \mathbb{R}^{2s \times 2s}$, \mathbb{Y} is a matrix of unknowns σ_i , $\mathbb{B} = (\mathbb{B}_i) \in \mathbb{R}^{2s \times 2}$ and

$$\mathbb{A}_{ii} = d_i^{-T} d_i^{-1} J + J d_i^{-T} d_i^{-1} + S_i - S_i^T - \sum_{j \neq i} [A_{ji}^i - (A_{ji}^i)^T], \quad (5.40)$$

$$\mathbb{A}_{ki} = \sum_{j \neq k, i} [(A_{jk}^i)^T - A_{jk}^i] + \sum_{j \neq k} [(B_{jk}^i)^T - B_{jk}^i] + \sum_{j \neq i} [((C_{ext})_{kj}^i)^T - (C_{ext})_{kj}^i], \quad i \neq k, \quad (5.41)$$

$$\mathbb{B}_i = R_i^0 - (R_i^0)^T, \quad (5.42)$$

$$\mathbb{Y} = (\mathbb{Y}_1 \cdots \mathbb{Y}_s)^T; \quad \mathbb{Y}_i = \sigma_i I_2, \quad (5.43)$$

with A_{ji}^i , B_{jk}^i , $(C_{ext})_{jk}^i$, S_i and R_i^0 defined as in equations (5.35)–(5.38) and (5.33), respectively.

Remark 5.1.2. *First, we would like to emphasize that the matrix \mathbb{A} from Equation (5.39) is a skew-symmetric matrix. This property will be proved using symbolic calculations and mathematical induction.*

As the first step one can show (using some symbolic calculator Mathematica®) that from equations (5.35)–(5.37) and (5.41) it follows that

$$(B_{i,j}^i)^T - B_{i,j}^i + ((C_{ext})_{j,j}^i)^T - (C_{ext})_{j,j}^i = (B_{j,i}^j)^T - B_{j,i}^j + ((C_{ext})_{i,i}^j)^T - (C_{ext})_{i,i}^j, \quad (5.44)$$

for all $i \neq j$, and

$$\begin{aligned} & (A_{k,j}^i)^T - A_{k,j}^i + (B_{k,j}^i)^T - B_{k,j}^i + ((C_{ext})_{j,k}^i)^T - (C_{ext})_{j,k}^i = \\ & = (A_{k,i}^j)^T - A_{k,i}^j + (B_{k,i}^j)^T - B_{k,i}^j + ((C_{ext})_{i,k}^j)^T - (C_{ext})_{i,k}^j, \end{aligned} \quad (5.45)$$

for all $j \neq i, j \neq k, k \neq i$.

Now, using equations (5.44)–(5.45) it can be shown that for $s = 2$ and $s = 3$ the matrix \mathbb{A} is skew-symmetric. Thus we can assume that the matrix \mathbb{A} is skew-symmetric for $s = l$. And we will show that \mathbb{A} is skew-symmetric for $s = l + 1$, where $l + 1 \leq n/2$. Thus, first we will show that $\mathbb{A}_{ki} = \mathbb{A}_{ik}$ for $i, k \neq l + 1$, where

$$\begin{aligned} \mathbb{A}_{ki} & \equiv \sum_{j \neq k, i}^{l+1} [(A_{jk}^i)^T - A_{jk}^i] + \sum_{j \neq k}^{l+1} [(B_{jk}^i)^T - B_{jk}^i] + \sum_{j \neq i}^{l+1} [((C_{ext})_{kj}^i)^T - (C_{ext})_{kj}^i] \\ \mathbb{A}_{ik} & \equiv \sum_{j \neq i, k}^{l+1} [(A_{ji}^k)^T - A_{ji}^k] + \sum_{j \neq i}^{l+1} [(B_{ji}^k)^T - B_{ji}^k] + \sum_{j \neq k}^{l+1} [((C_{ext})_{ij}^k)^T - (C_{ext})_{ij}^k] \end{aligned}$$

Note that we can write $\mathbb{A}_{ki} = \mathbb{A}_{ki}^0 + \mathbb{A}_{ki}^1$ and $\mathbb{A}_{ik} = \mathbb{A}_{ik}^0 + \mathbb{A}_{ik}^1$, where

$$\begin{aligned} \mathbb{A}_{ki}^0 & = \sum_{j \neq k, i}^l [(A_{jk}^i)^T - A_{jk}^i] + \sum_{j \neq k}^l [(B_{jk}^i)^T - B_{jk}^i] + \sum_{j \neq i}^l [((C_{ext})_{kj}^i)^T - (C_{ext})_{kj}^i] \\ \mathbb{A}_{ik}^0 & = \sum_{j \neq i, k}^l [(A_{ji}^k)^T - A_{ji}^k] + \sum_{j \neq i}^l [(B_{ji}^k)^T - B_{ji}^k] + \sum_{j \neq k}^l [((C_{ext})_{ij}^k)^T - (C_{ext})_{ij}^k]. \end{aligned}$$

From induction assumption it follows that $\mathbb{A}_{ik}^0 = \mathbb{A}_{ki}^0$, while for $j = l + 1$ from Equation (5.45) it follows that $\mathbb{A}_{ik}^1 = \mathbb{A}_{ki}^1$ (here one have to adapt indices in Equation (5.45), that is, one has to set $k = l + 1, j = k$ and $i = j$).

Second, for i or k equal to $l + 1$, again one can show that $\mathbb{A}_{ki} = \mathbb{A}_{ik}$ using the above equalities and equations (5.44)–(5.45) with the corresponding permutation of indices. Now, from the fact that $\mathbb{A}_{ik}^T = -\mathbb{A}_{ik}$, it follows that \mathbb{A} is skew-symmetric.

Remark 5.1.3. Since we have to count the number of floating point operations for forming the system (5.39), the following has to be emphasized.

The only contributions of $\mathcal{O}(s^3)$ flops are:

- calculation of \mathbb{A}_{ki} from Equation (5.41); for all k and i ,
- calculation of $(S_i - S_i^T)$ from Equation (5.38); for all i .

We continue with counting of the number of flops. First, we count the number of flops for forming A_{ki} from Equation (5.41). For that purpose we will calculate the flops number only in the first item $\sum_{j \neq k, i} [(A_{jk}^i)^T - A_{jk}^i]$, the other two are formed similarly.

Since the considered term is skew-symmetric, we only need matrix entries (2, 1) and (1, 2) from the matrix A_{jk}^i . These entries can be written in the following form:

$$A_{jk}^i = \mathcal{A}_{ij}^1 \mathcal{A}_{ij}^2 d_i^T,$$

where

$$\begin{aligned} \mathcal{A}_{ij}^1 &= \frac{d_i^{-T}}{(\omega_i^2 - \omega_j^2)}, \\ \mathcal{A}_{kj}^2 &= \frac{\omega_j^2 d_j^T d_j [d_k^{-1} J d_k - (d_k^{-1} J d_k + d_k^T J d_k^{-T}) d_j^T D_j J d_j]}{(\omega_j^2 - \omega_k^2)}. \end{aligned}$$

The matrices \mathcal{A}_{ij}^1 and \mathcal{A}_{kj}^2 are calculated in advance with $\mathcal{O}(n^2)$ flops. Thus, off-diagonal entries of A_{jk}^i can be calculated in 18 flops. Finally, the term $\sum_{j \neq k, i} [(A_{jk}^i)^T - A_{jk}^i]$ can be calculated in $18s + \mathcal{O}(1)$ flops. Similarly, the number of flops needed for the second term $\sum_{j \neq k} [(B_{jk}^i)^T - B_{jk}^i]$ is $18s + \mathcal{O}(1)$. Using this fact, $(C_{ext})_{kj}^i$ can be formed as the multiplication of the two matrices, then the number of needed flops for term $\sum_{j \neq i} [(C_{kj}^i)^T - C_{kj}^i]$ is $12s + \mathcal{O}(1)$,

similar holds for $S_i - S_i^T$. Finally, due to skew-symmetry of \mathbb{A} we only need $s \cdot (s - 1)/2$ off-diagonal entries. Altogether the number of flops needed for forming the matrix \mathbb{A} from Equation (5.39) is $36s^3 + \mathcal{O}(s^2) = 4.6n^3 + \mathcal{O}(n^2)$.

Now, since we would like to present the trace of the solution as the function of v , we substitute $d = \sqrt{v}c$ from Equation (5.7). Using this with equations (5.35)–(5.38), equations (5.40)–(5.43) become

$$\begin{aligned}\mathbb{A}_{ii} &= \frac{1}{v}F_i + v(\tilde{S}_i - \tilde{S}_i^T - \sum_{j \neq i} [\tilde{A}_{ji}^i - (\tilde{A}_{ji}^i)^T]), \\ \mathbb{A}_{ij} &= v\tilde{\mathbb{A}}_{ij}, \\ \mathbb{B}_i &= v\tilde{\mathbb{B}}_i, \\ \mathbb{Y}_i &= \sigma_i(v)I,\end{aligned}$$

where F_i is given as

$$F_i \equiv c_i^{-T} c_i^{-1} J + J c_i^{-T} c_i^{-1} = \frac{1}{\det(c_i)} \begin{pmatrix} 0 & \|c_i\|_F^2 \\ -\|c_i\|_F^2 & 0 \end{pmatrix},$$

and where the matrices $\tilde{A}_{ji}^i, \tilde{\mathbb{A}}_{ij}, \tilde{\mathbb{B}}_i, \tilde{S}_i$ are obtained from equations (5.35)–(5.38) and (5.41)–(5.42), replacing d_i with c_i for all i .

Using the above notation, system (5.47) can be written as:

$$\left(\frac{1}{v^2} \tilde{\mathbb{A}}_0 + \tilde{\mathbb{A}}_1 \right) \begin{pmatrix} \sigma_1(v)I \\ \sigma_2(v)I \\ \vdots \\ \sigma_s(v)I \end{pmatrix} = \tilde{\mathbb{B}}, \quad (5.46)$$

where

$$\begin{aligned} (\tilde{A}_0)_{ii} &= F_i, & (\tilde{A}_0)_{ij} &= 0, \quad \text{for } i \neq j, \\ (\tilde{A}_1)_{ii} &= \tilde{S}_i - \tilde{S}_i^T - \sum_{j \neq i} [\tilde{A}_{ji}^i - (\tilde{A}_{ji}^i)^T], & (\tilde{A}_1)_{ij} &= \tilde{A}_{ij}, \quad \text{for } i \neq j. \end{aligned}$$

Note that \tilde{A}_0 is a block diagonal skew-symmetric matrix, and that \tilde{A}_0 and \tilde{A}_1 do not depend on viscosity v .

Also, note that 2×2 block matrices from the system matrix of the system (5.46) are skew-symmetric, thus system (5.46) is equivalent to the $s \times s$ linear system

$$\left(\frac{1}{v^2} \mathbb{A}^0 + \mathbb{A}^1 \right) \begin{pmatrix} \sigma_1 \\ \sigma_2 \\ \vdots \\ \sigma_s \end{pmatrix} = B. \quad (5.47)$$

Recall that from Remark 5.0.1 follows that for every v such that the matrix A from (5.2) is stable, system (5.47) is regular. This means that the solution $\sigma_1, \dots, \sigma_s$ of system (5.47) is unique. Now using equations (5.22), (5.23) and (5.27) we get non-diagonal blocks of X_{11} and X_{22} , while diagonal blocks can be obtained from Equation (5.29). For X_{12} one needs the matrix S which can be obtained from equations (5.19) and (5.26). All this together gives the solution \hat{X} of the considered Lyapunov equation.

5.2 Minimization of the trace of the solution of the Lyapunov equation

Since we want to determine optimal damping in the sense of criterion (5.5), we are interested in minimization of the trace of the solution of the Lyapunov

equation (5.2) as the function of damping viscosity parameter $v > 0$. Particularly, we are interested in finding optimal viscosity v_{opt} such that

$$v_{opt} = \arg \min_{v \in \mathbb{R}_+} \text{trace}(\widehat{X}(v)), \quad (5.48)$$

where $\widehat{X}(v)$ is the solution of Lyapunov equation (5.2).

Since we have calculated solution $\widehat{X}(v)$, in the following we continue with deriving the trace of the solution of the Lyapunov equation as the function of parameter v .

From Equation (5.21) it follows that the trace of the solution \widehat{X} of the Lyapunov equation (5.2) is given by

$$\text{trace } \widehat{X} = \sum_{i=1}^s \text{trace}(\xi_{ii} + \eta_{ii}).$$

Using (5.24) and (5.29) we obtain the following equalities

$$\begin{aligned} \text{trace } \widehat{X} &= \sum_{i=1}^s \text{trace}(2\xi_{ii} + \omega_i^{-1}t_{ii}) \\ &= \sum_{i=1}^s \text{trace}(2d_i^{-T}d_i^{-1} + 2\sigma_i d_i^{-T}d_i^{-1}J + \omega_i^{-1}t_{ii} - 2 \sum_{\substack{j \neq i \\ j=1}}^s d_i^{-T}d_j^T \frac{\omega_j t_{ji} - \omega_i t_{ij}^T}{\omega_i^2 - \omega_j^2}). \end{aligned}$$

Using t_{ij} from (5.27) and $d = \sqrt{v}c$ for the trace as the function of viscosity v we have

$$\begin{aligned}
& \text{trace}(\widehat{X}(v)) = \\
& = v \sum_i \left(\frac{2}{v^2} \text{trace}(c_i^{-T} c_i^{-1} + \sigma_i(v) c_i^{-T} c_i^{-1} J) + \frac{\text{trace}(c_i c_i^T)}{2\omega_i^2} \right. \\
& + \text{trace} \sum_{\substack{k \neq i \\ k=1}}^s \frac{1}{\omega_i^2 - \omega_k^2} (M_{ik}^3 + \sigma_k(v) M_{ik}^1 - \sigma_i(v) M_{ik}^2) c_i^T \\
& - \text{trace} \sum_{\substack{j \neq i \\ j=1}}^s \frac{2c_i^{-T} c_j^T \omega_j}{\omega_i^2 - \omega_j^2} \left[\frac{c_j}{2\omega_j} + \sum_{\substack{k \neq j \\ k=1}}^s \frac{\omega_j}{\omega_j^2 - \omega_k^2} (M_{jk}^3 + \sigma_k(v) M_{jk}^1 - \sigma_j(v) M_{jk}^2) \right] c_i^T \\
& \left. + \text{trace} \sum_{\substack{j \neq i \\ j=1}}^s \frac{2c_i^{-T} c_j^T c_j \omega_i}{\omega_i^2 - \omega_j^2} \left[\frac{c_i^T}{2\omega_i} + \sum_{\substack{k \neq i \\ k=1}}^s \frac{\omega_i}{\omega_i^2 - \omega_k^2} (M_{ik}^3 + \sigma_k(v) M_{ik}^1 - \sigma_i(v) M_{ik}^2)^T \right] \right), \tag{5.49}
\end{aligned}$$

where

$$\begin{aligned}
M_{jk}^1 &= c_j c_k^{-1} J c_k - c_j (c_k^{-1} J c_k + c_k^T J c_k^{-T}) c_j^T \widetilde{D}_j J c_j, \\
M_{jk}^2 &= J c_j^{-T} c_k^T c_k - (J c_j^{-T} d_k^T c_k c_j^T + c_j c_k^T c_k c_j^{-1} J) \widetilde{D}_j J c_j, \\
M_{jk}^3 &= c_j + c_j^{-T} c_k^T c_k - (c_j^{-T} c_k^T c_k c_j^T - c_j c_k^T c_k c_j^{-1}) \widetilde{D}_j J c_j, \\
\widetilde{D}_i &= (J c_i c_i^T + c_i c_i^T J)^{-1}.
\end{aligned}$$

It is important to emphasize that expressions in the square brackets depend only on two indices, which means that for calculation of the sums in Equation (5.49) one needs only $\mathcal{O}(s^2)$ flops.

It can be easily shown that the required number of flops for calculation of the trace for given viscosity v is equal to

$$\left(36 + \frac{1}{3} \right) \left(\frac{m}{4} \right)^3 + \mathcal{O}(m^2) \approx 0.57m^3 + \mathcal{O}(m^2) \quad \text{flops}, \tag{5.50}$$

where (with $s = m/4$)

- $36s^3 + \mathcal{O}(s^2)$ is a number of flops for forming the matrix of the linear system (5.39) and the corresponding vector of the right-hand side
- $\frac{1}{3}s^3 + \mathcal{O}(s^2)$ is a number of flops for calculation of the $LJ_S L^T$ decomposition of the matrix of the linear system (5.46). Such decomposition can be obtained using a well-known method by Bunch and Parlett [16].
- $\mathcal{O}(s^2)$, all additional calculation.

Since our penalty function $f(v) = \text{trace}(\widehat{X}(v))$ is continuously differentiable, the minimization process can be easily performed using some minimization process, for example the Newton method. For the Newton minimization method one needs $f'(v)$ and $f''(v)$. Both derivatives will be obtained from Equation (5.49) using $\sigma'_i(v)$ and $\sigma''_i(v)$. Since $\sigma'_i(v)$ and $\sigma''_i(v)$ can be obtained from Equation (5.46) (using the same LU decomposition of the matrix $(1/v^2 \widetilde{A}_0 + \widetilde{A}_1)$), both $f'(v)$ and $f''(v)$ can be obtained with $\mathcal{O}(s^2)$ flops.

Due to the fact that formulae for $f'(v)$ and $f''(v)$ can be obtained directly, but they are much more complicated than the one for the trace (5.49), we will not display them here; however, the MATLAB functions which calculate function $f(v) = \text{trace}(\widehat{X}(v))$ and derivatives $f'(v)$ and $f''(v)$ are available from the author upon request.

5.3 Numerical experiments

In this section we will illustrate the performance of a new algorithm and compare it with the algorithm from [14]. Comparison will be performed on Example 5.1.

Example 5.1. *We consider an n -mass oscillator or oscillator ladder shown in Figure 5.1. Recall that this mechanical system can be described by differential equation*

$$M\ddot{x} + D\dot{x} + Kx = 0. \quad (5.51)$$

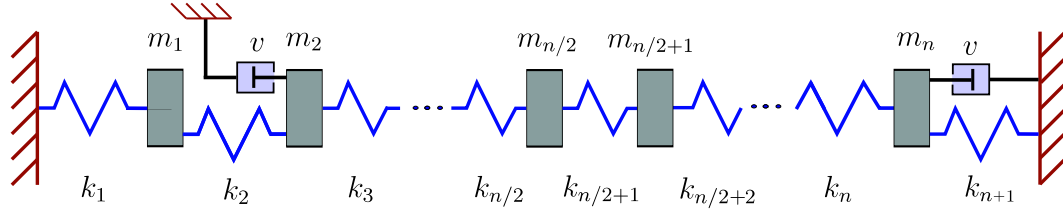

Figure 5.1: The n -mass oscillator with two dampers

For such systems, the mass matrix is given by

$$M = \text{diag}(m_1, m_2, \dots, m_n),$$

and for the stiffness matrix it holds

$$K = \begin{pmatrix} k_1 + k_2 & -k_2 & & & & \\ -k_2 & k_2 + k_3 & -k_3 & & & \\ & \ddots & \ddots & \ddots & & \\ & & & -k_{n-1} & k_{n-1} + k_n & -k_n \\ & & & & -k_n & k_n + k_{n+1} \end{pmatrix},$$

$$D \equiv C_u + C_{ext} = C_u + v e_i e_i^T + v e_j e_j^T, \quad \text{with } C_u = 0.$$

Note that in this example we have two dampers of the same viscosity and the rank of the matrix C_{ext} is two. In this example we will consider a particular configuration which will yield to a system which has eigenfrequencies double in pairs.

Dimension n will be an even number and we will consider the following configuration (see Figure 5.1):

$$\begin{aligned} k_i &= 1, & \text{for } i \neq n/2 + 1; \\ k_{n/2+1} &= 0.0001; \\ m_1 &= m_2 = \dots = m_n = 1. \end{aligned} \tag{5.52}$$

In order to compare the time ratio for a new algorithm and the algorithm from [14], dimension n will vary from 800 to 1300.

The above mechanical system with this configuration has some interesting properties: the undamped eigenfrequencies come in close pairs, that is we have the following structure:

$$\Omega = \text{diag}(\omega_1, \omega_2, \omega_3, \omega_4, \dots, \omega_{n-1}, \omega_n), \quad (5.53)$$

where $\omega_{2i-1} \approx \omega_{2i}$ and $\omega_{2i} < \omega_{2i+1}$, for $i = 1, \dots, \frac{n}{2}$. Thus for the purpose of our approach described in this chapter we will set

$$\hat{\Omega} = \text{diag}(\hat{\omega}_1, \hat{\omega}_1, \hat{\omega}_2, \hat{\omega}_2, \dots, \hat{\omega}_{\frac{n}{2}}, \hat{\omega}_{\frac{n}{2}}), \quad (5.54)$$

where $\hat{\omega}_i = \frac{\omega_{2i} + \omega_{2i-1}}{2}$, for all $i = 1, \dots, \frac{n}{2}$.

Figure 5.2 shows the speed ratio between the new algorithm and the algorithm from [14] where the number of iteration steps goes from 8 to 16.

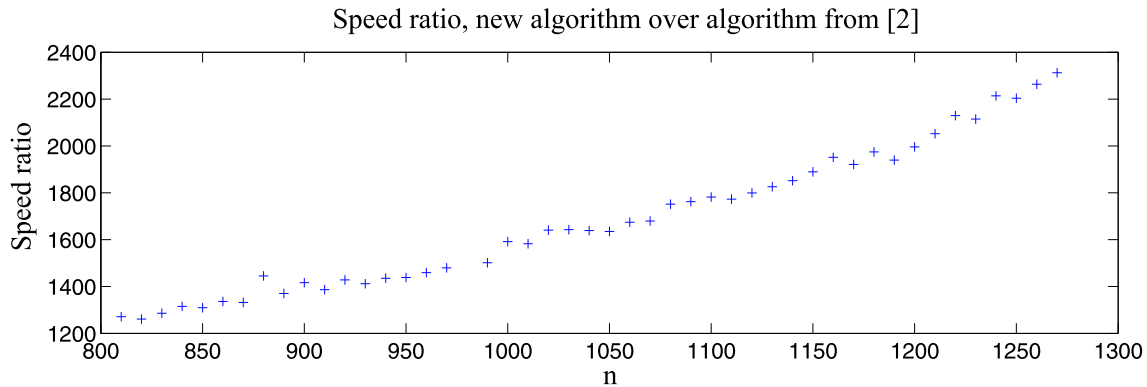

Figure 5.2: Speed ratio

From Figure 5.2 we can see that we have achieved considerable time acceleration. Indeed, from Equation (5.50) follows that for a certain number of iteration steps in the Newton process (n_{iter}) the number of flops for the whole

optimization with the new algorithm (see items below (5.50)) is approximately

$$\left(36 + \frac{1}{3}n_{iter}\right) \frac{m^3}{64} + \mathcal{O}(m^2). \quad (5.55)$$

Furthermore, the algorithm from [14] needs approximately

$$96m^3n_{iter} + \mathcal{O}(m^2) \quad (5.56)$$

for the whole optimization. Here we would like to emphasize that the algorithm from [14] uses the Bartels-Stewart method for solving Lyapunov equations.

The experiments are performed on Xenon with 2 GB memory and 2.33 GHz. We compare times needed for optimization which includes flops ratio and memory usage.

Note that from Figure 5.2 one can also see that we have an additional speed up with an increase in the dimension of the problem. This is based on the fact that the new algorithm uses the matrices of dimension $n \times n$, while the algorithm from [14] uses the matrices $2n \times 2n$ and requires more storage.

For systems with such structure, with this approach we can now use the "Direct" approach or presented heuristics for dampers' position optimization. Similarly to the case of one-dimensional damping (described in Section 4.1.1), now we can also efficiently optimize viscosity at given dampers' positions.

5.4 Conclusions

Optimization of damping viscosity of damping systems is a very demanding problem, which becomes more complicated in the presence of multiple eigenfrequencies. In some cases, the trace of the Lyapunov equation can be calculated by a formula, like for one-dimensional damping which was considered in [57]. In this chapter we consider a second order damped vibrational

system whose undamped eigenfrequencies $\omega_1, \omega_2, \dots, \omega_n$, are double in pairs. We present a formula which gives the solution of the corresponding Lyapunov equation, which then allows us to calculate the first and second derivatives of the trace of the solution, with no extra cost. The new algorithm requires $(36 + \frac{1}{3}n_{iter}) \frac{m^3}{64} + \mathcal{O}(m^2)$ flops contrary to the usual algorithms based on the Bartels-Stewart method which needs $96m^3n_{iter} + \mathcal{O}(m^2)$ for the whole optimization. With this algorithm, the optimization process for determination of optimal damping can be considerably accelerated.

Future research

Throughout this thesis we made one very important assumption, i.e. that we can simultaneously diagonalize the mass and the stiffness matrices from mechanical systems. This assumption can be a bottleneck for systems with a very large dimension. Thus in the future work we will include the consideration of large scale problems, trying to avoid the explicit calculation of the matrix Φ which simultaneously diagonalizes the mass and the stiffness matrices.

Further, since throughout this thesis we have used direct solvers such as the Bartels-Stewart method for solving reduced Lyapunov equations, it will be interesting to try to additionally accelerate solving these Lyapunov equations, for example with iterative approaches like ADI methods. This approach will be very important for larger dimensions.

In the process of deriving the methods presented in Chapters 2 and 3, we have considered several model reduction methods based on the existing approaches. These attempts were not successful but this is an important area for future research.

In addition to minimization of the trace of the solution of the Lyapunov equation, one interesting problem is also minimization of the 2-norm of the solution of the considered Lyapunov equation. We will try to apply the obtained results to this optimization problem.

Bibliography

- [1] S. Adhikari, *Damping modelling using generalized proportional damping*, Journal of Sound and Vibration **293** (2006), 156–170.
- [2] A. Antoulas, *Approximation of large-scale dynamical systems*, SIAM Publications, Philadelphia, PA, 2005.
- [3] Z. Bai, J. Demmel, J. Dongarra, A. Ruhe, and H. van der Vorst, *Templates for the solution of algebraic eigenvalue problems: A practical guide*, SIAM, Philadelphia, 2000.
- [4] Z. Bai and Y. Su, *SOAR: A second-order Arnoldi method for the solution of the quadratic eigenvalue problem*, Matrix Anal. Appl. **26** (2005), no. 3, 640–659.
- [5] R.H. Bartels and G.W. Stewart, *A solution of the matrix equation $AX + XB = C$* , Comm. ACM **15** (1972), no. 9, 820–826.
- [6] C.A. Beattie and S. Gugercin, *Krylov-based model reduction of second-order systems with proportional damping*, Proceedings of the 44th IEEE Conference on Decision and Control, IEEE, December 2005, pp. 2278–2283.
- [7] P. Benner, D. Kressner, V. Sima, and A. Varga, *The SLICOT-toolboxes for MATLAB (in German)*, at – Automatisierungstechnik **58** (2010), no. 1, 15–25, English version available as SLICOT Working Note 2009-1, August 2009, at: www.slicot.org.

-
- [8] P. Benner, R. C. Li, and N. Truhar, *On the ADI method for Sylvester equations*, J. Comput. Appl. Math. **233** (2009), no. 4, 1035–1045.
- [9] P. Benner, V. Mehrmann, and D.C. Sorensen, *Dimension reduction of large-scale systems*, Lecture Notes in Computational Science and Engineering, Springer-Verlag, Berlin/Heidelberg, Germany, 2005.
- [10] P. Benner and J. Saak, *Efficient balancing based MOR for second order systems arising in control of machine tools*, Proceedings of the MathMod 2009 (Vienna, Austria) (I. Troch and F. Breitenecker, eds.), ARGESIM-Reports, no. 35, Vienna Univ. of Technology, ARGE Simulation News, January 2009, pp. 1232–1243.
- [11] P. Benner, Z. Tomljanović, and N. Truhar, *Damping optimization in linear vibrating systems using dimension reduction*, accepted for publication in Proceedings of the 10th International Conference on Vibration Problems, Prague.
- [12] ———, *Dimension reduction for damping optimization in linear vibrating systems*, Z. Angew. Math. Mech. **91** (2011), no. 3, 179 – 191, DOI: 10.1002/zamm.201000077.
- [13] ———, *Optimal damping of selected eigenfrequencies using dimension reduction*, submitted for publication in NLAA, 2011.
- [14] K. Brabender, *Optimale Dämpfung von linearen Schwingungssystemen*, Ph.D. thesis, Fernuniversität, Hagen, 1998.
- [15] R. P. Brent, *Algorithms for minimization without derivatives*, Prentice-Hall, Englewood Cliffs, N.J., 1973.
- [16] J.R. Bunch and B.N. Parlett, *Direct methods for solving symmetric indefinite systems of linear equations*, SIAM J. Numer. Anal. **8** (1971), 639–655.
- [17] R. Byers, *A LINPACK-style condition estimator for the equation $AX + XB^T = C$* , IEEE Trans. Automat. Control AC **29** (1984), no. 10, 926–928.

-
- [18] Y. Cao and L. Petzold, *An error estimate for matrix equations*, Applied Numerical Mathematics **50** (2004), 395–407.
- [19] Y. Chahlaoui, K. A. Gallivan, A. Vandendorpe, and P. Van Dooren, *Model reduction of second-order systems*, MIMS EPrints [<http://eprints.ma.man.ac.uk/perl/oai2>] (United Kingdom), 2006.
- [20] Y. Chahlaoui, D. Lemonnier, A. Vandendorpe, and P. Van Dooren, *Second order balanced truncation*, Linear Algebra and its Applications **415** (2004), no. 2-3, 373–384.
- [21] S. Cox, I. Nakić, A. Rittmann, and K. Veselić, *Lyapunov optimization of a damped system*, Systems & Control Letters **53** (2004), 187–194.
- [22] B.N. Datta, *Numerical methods for linear control systems*, Elsevier Academic Press, London, UK, 2004.
- [23] S. Elliott, *Signal processing for active control*, Academic Press, London, 2000.
- [24] P. Freitas and P Lancaster, *On the optimal value of the spectral abscissa for a system of linear oscillators*, SIAM J. Matrix Anal. Appl. **21** (1999), 195–208.
- [25] P. L. Gatti and V. Ferrari, *Applied structural and mechanical vibrations*, E&FN Spon, London, 1999.
- [26] W.K. Gawronski, *Advanced structural dynamics and active control of structures*, Springer, New York, USA, 2004.
- [27] M. Gu and M. L. Overton, *An algorithm to compute \mathbf{Sep}_λ* , SIAM Journal on Matrix Analysis and Applications **28** (2006), no. 2, 348–359.
- [28] S. J. Hammarling, *Numerical solution of the stable, nonnegative definite Lyapunov equation*, IMA Journal of Numerical Analysis **2** (1982), no. 3, 303–323.

-
- [29] C. M. Harris and A. G. Piersol, *Harris' shock and vibration handbook*, McGraw-Hill, New York, 2002.
- [30] J. He and Z. F. Fu, *Modal analysis*, Butterworth-Heinemann, Oxford, 2001.
- [31] N. J. Higham, *A survey of condition number estimation for triangular matrices*, SIAM Review **29** (1987), 575–596.
- [32] ———, *Perturbation theory and backward error for $AX - XB = C$* , BIT **33** (1993), 124–136.
- [33] N. J. Higham, *Accuracy and stability of numerical algorithms*, SIAM, Philadelphia, PA, 1996.
- [34] N. A. Hizal and M. Gürgöze, *Lumped parameter representation of a longitudinally vibrating elastic rod viscously damped in-span*, Journal of Sound and Vibration **216** (1998), no. 2, 328–336.
- [35] P. Lancaster and I. Zaballa, *Diagonalizable quadratic eigenvalue problems*, Mechanical Systems and Signal Processing **23** (2009), no. 4, 1134–1144.
- [36] R.-C. Li and Z. Bai, *Structure-preserving model reduction using a Krylov subspace projection formulation*, Comm. Math. Sci. Vol. **3** (2005), 179–199.
- [37] D.G. Meyer and S. Srinivasan, *Balancing and model reduction for second order form linear systems*, IEEE Trans. Automat. Contr. **41** (1996), no. 11, 1632–1644.
- [38] P.C. Müller and W.O. Schiehlen, *Linear Vibrations*, Martinus Nijhoff Publishers, Dordrecht Boston Lancaster, 1985.
- [39] I. Nakić, *Optimal damping of vibrational systems*, Ph.D. thesis, Fernuniversität, Hagen, 2002.
- [40] J. A. Nelder and R. Mead, *A simplex method for function minimization*, Computer Journal **7** (1965), 308–313.

-
- [41] R.A. Horn, C.R. Johnson, *Topics in matrix analysis*, Cambridge University Press, Cambridge, 1991.
- [42] T. Reis and T. Stykel, *Balanced truncation model reduction of second-order systems*, Math. Comput. Model. Dyn. Syst. **14** (2008), no. 5, 391–406.
- [43] C.W. De Silva, *Vibration, fundamentals and practice*, CRC Press, Boca Raton, FL, 2000.
- [44] M. Slowik, P. Benner, and V. Sima, *Evaluation of the linear matrix equation solvers in SLICOT*, J. Numer. Anal., Ind. Appl. Math. **2** (2007), no. 1–2, 11–34.
- [45] D. C. Sorensen and Y. Zhou, *Direct methods for matrix Sylvester and Lyapunov equations*, J. Appl. Math. **6** (2003), 277–303.
- [46] J.-G. Sun, *Estimation of the separation of two matrices*, Journal of Computational Mathematics **2** (1984), 189–200.
- [47] J. I. Taylor, *The vibration analysis handbook*, VCI, Tampa, Florida, 1994.
- [48] F. Tisseur and K. Meerbergen, *The quadratic eigenvalue problem*, SIAM Rev. **43** (2001), no. 2, 235–286.
- [49] Z. Tomljanović, N. Truhar, and K. Veselić, *Optimizing a damped system - a case study*, International Journal of Computer Mathematics **88** (2011), no. 7, 1533–1545, DOI: 10.1080/00207160.2010.521547, 2011 (iFirst).
- [50] N. Truhar, *An efficient algorithm for damper optimization for linear vibrating systems using Lyapunov equation*, J. Comput. Appl. Math. **172** (2004), no. 1, 169–182.
- [51] N. Truhar and Z. Tomljanović, *Estimation of optimal damping for mechanical vibrating systems*, Intl. J. Appl. Math. Mech. **5** (2009), no. 5, 14–26.

-
- [52] N. Truhar and K. Veselić, *On some properties of the Lyapunov equation for damped systems*, *Mathematical Communications* **9** (2004), no. 2, 189–197.
- [53] ———, *An efficient method for estimating the optimal dampers' viscosity for linear vibrating systems using Lyapunov equation*, *SIAM J. Matrix Anal. Appl.* **31** (2009), no. 1, 18–39.
- [54] J. Vanbiervliet, B. Vandereycken, W. Michiels, S. Vandewalle, and M. Diehl, *The smoothed spectral abscissa for robust stability optimization*, *SIAM Journal on Optimization* **20** (2009), no. 1, 156–171.
- [55] K. Veselić, *Damped oscillations of linear systems – a mathematical introduction*, submitted for publication in Springer.
- [56] ———, *On linear vibrational systems with one-dimensional damping*, *Appl. Anal.* **29** (1988), 1–18.
- [57] ———, *On linear vibrational systems with one-dimensional damping ii*, *Integral Equations Operator Theory* **13** (1990), no. 6, 883–897.
- [58] ———, *Modal approximations to damped linear systems*, (2009), Preprint 10/2008, Department of Mathematics, J. J. Strossmayer University of Osijek.
- [59] K. Veselić, K. Brabender, and K. Delinić, *Passive control of linear systems*, *Applied Mathematics and Computation*, M. Rogina et al. Eds. Dept. of Math. Univ. Zagreb (2001), 39–68.
- [60] E. L. Wachspress, *Iterative solution of the Lyapunov matrix equation*, *Appl. Math. Lett.* **1** (1988), no. 1, 87–90.

Curriculum Vitae

Zoran Tomljanović was born on 2 May 1982 in Našice, Croatia. He grew up and completed his primary and secondary school in Našice as well. In 2001 he started to study at the Department of Mathematics, University of Zagreb. He obtained his BSc degree in mathematics (branch applied mathematics) in December 2005. Work on his diploma thesis "Numerical solution of the Lyapunov equation" (in Croatian) was supervised by Prof. Zlatko Drmač. In December, 2005 he enrolled in the PhD studies in the Department of Mathematics, University of Zagreb under supervision of Prof. Ninoslav Truhar.

Since February 2006 he has been working as a teaching assistant at the Department of Mathematics, Josip Juraj Strossmayer University of Osijek, where he has taught exercises in several undergraduate and graduate courses. He is working as an investigator in scientific project "Passive control of mechanical models" (Croatian Ministry of Science, Education and Sports). He was principal investigator in the project "Optimization algorithms for determination of optimal damping in mechanical systems" in cooperation with Prof. Peter Benner and Prof. Ninoslav Truhar. This project was supported by the Croatian Science Foundation.

During his postdoctoral studies he paid several one-month visits (in 2007, 2008 and 2010) and one two-months visits (in 2009) to Prof. Benner's working group at TU Chemnitz. In 2010 he also paid a one-month visit at the Max Planck Institute in Magdeburg. He visited and gave presentations at workshops and seminars in Chemnitz, Zürich, Novi Sad and Berlin.

Životopis

Zoran Tomljanović rođen je 2. svibnja 1982. godine u Našicama, Hrvatska. Odrastao je u Našicama gdje je završio osnovnu i srednju školu. 2001. godine upisao se na Matematički odjel, Prirodoslovno-matematičkog fakulteta, Sveučilišta u Zagrebu. Diplomirao je u prosincu 2005. godine kao inženjer matematike (smjer: primijenjena matematika), pod mentorstvom prof. Zlatka Drmača s diplomskim radom: Numeričko rješavanje Ljapunovljeve jednadžbe. Tada se upisao na Sveučilišni poslijediplomski doktorski studij na Matematičkom odjelu Prirodoslovno-matematičkog fakulteta Sveučilišta u Zagrebu pod mentorstvom prof. Ninoslava Truhara.

Od veljače 2006. godine radi kao asistent na Odjelu za matematiku, Sveučilišta Josipa Jurja Strossmayera u Osijeku, gdje je držao vježbe iz više dodiplomskih i diplomskih predmeta. Radi kao istraživač na projektu "Pasivna kontrola mehaničkih modela" (Ministarstvo znanosti, obrazovanja i športa). Bio je voditelj projekta "Optimizacijski algoritmi za određivanje optimalnog prigušenja kod mehaničkih sustava" koji je bio u suradnji s prof. Peterom Bennerom i prof. Ninoslavom Truharom. Taj projekt odobrila je Hrvatska zaklada za znanost.

Tijekom svog poslijediplomskog studija više je puta posjetio radnu skupinu profesora Petera Bennera. 2007., 2008. i 2010. godine bio je u jednomjesečnom posjetu, a 2009. godine u dvomjesečnom posjetu na TU, Chemnitz. 2010. godine bio je također u jednomjesečnom posjetu na Max Planck Institute u Magdeburgu. Posjetio je i održao prezentacije na radionicama i seminarima u Chemnitzu, Zürichu, Novom Sadu i Berlinu.

Summary

In this thesis we consider optimization of damping in mechanical vibrating systems. When one has to find optimal positions together with corresponding viscosities of dampers in a mechanical vibrating system based on energy minimization, then numerous Lyapunov equations have to be solved. Thus, we have introduced different approaches which significantly accelerate the optimization procedure.

In Chapter 2 we consider the case when all undamped eigenfrequencies have to be damped and propose a dimension reduction technique which calculates approximation of the solution of the corresponding Lyapunov equation. We derive an error bound for this approximation which is then used in the process of viscosities optimization. Numerical experiments confirm the ability of this approximation technique to significantly accelerate the optimization process. On the numerical example we have shown that near optimal positions we can accelerate the optimization process around 15 times and still ensure that the optimal positions are found.

From the point of a dimension reduction technique, the case of damping a selected part of undamped eigenfrequencies is more interesting. This is investigated in Chapter 3. In this case, the right-hand side of the corresponding Lyapunov equation is low rank and this allows better approximation using the dimension reduction technique. In this case we have derived an algorithm for the approximation of the trace of the Lyapunov equation and the corresponding error bound which uses the structure of the system. Then, viscosities are optimized using this error bound. On numerical examples we have shown

that the optimization process can be considerably accelerated, that is, we have shown that near optimal positions we can accelerate the optimization process around 800 times while ensuring that we still find the optima within the limit of tolerance.

While Chapters 2 and 3 are mainly devoted to viscosities optimization, Chapter 4 is devoted to optimization of dampers' positions. In this chapter we propose several approaches which accelerate optimization of dampers' positions. First, we propose two heuristics; i.e. the "Multigrid-like" and the "Discrete to continuous" optimization approach. They significantly reduce the number of Lyapunov equations which have to be solved and they show very good performance on numerical examples. Furthermore, we also present the optimization approach which combines approximation algorithms and heuristical approaches. This approach allows us to perform optimization of dampers' positions and corresponding viscosities on larger dimensions. Besides these approaches that use heuristics, we also propose an algorithm that determines the area which contains the optimal dampers' positions. That algorithm is derived using the error bound derived in Chapter 3 and it works efficiently for specially structured systems.

In the last chapter we investigate a case study for a very structured system. The main properties are that internal damping is zero and that undamped eigenfrequencies come in close pairs. We have derived a formula for the trace of the corresponding Lyapunov equation. This formula is the closest generalization of the case where rank one-dimensional damping was considered. With this approach we can significantly accelerate the optimization procedure, and the factor of acceleration is greater than 1000.

Sažetak

U ovoj radnji promatramo optimizaciju prigušenja kod mehaničkih vibracijskih sistema. Prilikom određivanja optimalnog prigušenja u mehaničkim vibracijskim sistemima, moraju se riješiti brojne Ljapunovljeve jednadžbe. Stoga smo uveli različite pristupe koji značajno ubrzavaju optimizacijski proces.

U 2. poglavlju promatramo slučaj kada sve neprigušene svojstvene frekvencije moraju biti prigušene i predstavljamo tehniku koja koristi redukciju dimenzije. Tehnika koja koristi redukciju dimenzije računa aproksimaciju rješenja odgovarajuće Ljapunovljeve jednadžbe. Izveli smo ocjenu pogreške za spomenutu aproksimaciju koja se poslije koristi u procesu optimizacije viskoznosti. Numerički eksperimenti potvrđuju mogućnosti te aproksimacijske tehnike kojom se značajno ubrzava optimizacijski proces. Na numeričkim primjerima pokazali smo da oko optimalne pozicije možemo ubrzati optimizacijski proces oko 15 puta i uz to još uvijek možemo dobiti dobre optimalne pozicije.

Sa stajališta tehnika koje koriste redukciju dimenzije, više je zanimljiv slučaj prigušenja dijela neprigušenih svojstvenih frekvencija. To smo proučavali u 3. poglavlju. U ovom je slučaju desna strana pripadne Ljapunovljeve jednadžbe malog ranga i to nam omogućava bolju aproksimaciju prilikom korištenja redukcije dimenzije. U tom slučaju izveli smo algoritam koji računa aproksimaciju traga rješenja Ljapunovljeve jednadžbe i odgovarajuću ocjenu pogreške koja koristi strukturu sistema. Uz tu ocjenu pogreške možemo učinkovito optimizirati viskoznost. Na numeričkim primjerima pokazali smo da se optimizacijski proces može značajno ubrzati, odnosno, pokazali smo da u okolini optimalnih pozicija možemo ubrzati optimizacijski proces oko 800 puta i uz to izračunati optimalno prigušenje unutar granica tolerancije.

Dok smo 2. i 3. poglavlje posvetili uglavnom optimizaciji viskoznosti, 4. poglavlje posvećeno je optimizaciji položaja prigušivača. U tom poglavlju predstavljamo nekoliko pristupa koji ubrzavaju optimizaciju položaja prigušivača. Prvo predstavljamo dvije heuristike: "Multigrid-like" i "Discrete to

continuous” optimizacijski pristup. Oni značajno smanjuju broj Ljapunovljevih jednadžbi koje moraju biti riješene i pokazuju vrlo dobre performanse na numeričkim primjerima. Nadalje predstavljamo optimizacijski pristup koji povezuje aproksimacijske algoritme s algoritmima koji koriste heuristike. Taj nam pristup omogućava da izračunamo optimalne položaje prigušivača i odgovarajuće viskoznosti čak i za veće dimenzije. Osim tih pristupa koji koriste heuristike predstavili smo i algoritam koji određuje područje koje sadrži optimalne pozicije prigušivača. Taj je algoritam izveden korištenjem ocjene pogreške iz 3. poglavlja i on je učinkovit za posebno strukturirane sisteme.

U posljednjem poglavlju istražujemo studij slučaja za vrlo strukturiran sistem. Glavna su svojstva da je unutrašnje prigušenje nula i da neprigušene frekvencije dolaze u bliskim parovima. Izveli smo formulu za trag rješenja pripadne Ljapunovljeve jednadžbe. Ta je formula najbliža generalizacija slučaja kada se proučava jednodimenzionalno prigušenje. Tim pristupom možemo značajno ubrzati optimizacijski proces, a faktor ubrzanja veći je od 1000.